



# PRODUCT CATALOGUE







Careon Healthcare Solutions provide wide range of sterile surgical drapes, packs, gowns, aprons, instrument covers and surgical consumables for all type of surgical procedures. We are using different types of medical grade non woven breathable/non breathable, bacteria barrier fabrics of different protection levels and comforts. Sterile and easy to use drapes and packs give total protection throughout the surgical procedures.

## ABOUT US

Careon was stated in 1991 by a team of experts having years of experience in the manufacturing medical disposables with a commitment to control hospital infections by providing top quality single use medical apparels

## QUALITY POLICY

"Careon is committed to manufacture & market medical disposable products confirming to national and international standards. Careon values customer satisfaction as paramount objective. We believe in delivering products which fulfill medical requirements and expectations in terms of product quality performance and safety at optimum cost".

### **Surgical Drapes and Packs**

Most of the hospitals use alkaline chemicals and detergents for washing surgical sheets. Due to this, the surgical sheets tend to acquire a PH value higher than 7, which aggravate the wounds in contact. Also the foaming property of the detergents lead to creation of bubbles in blood circulation which is very dangerous.

### **Sterility**

Using sub-standard, Non-Hygiene and high bacteria level sheets lead to higher chances of infection, irritations of the wound, longer healing time, more in take of antibiotics and longer stay of patients in the hospitals. In this era of modern safety facilities and values for human life, Careon is using internationally accepted SMS, different types of absorbent and repellent non woven fabrics which are friendly and non irritant to human body.

All our Drapes and Packs are air tight packed in our most modern clean room and E.T.O. Sterilized. We offer sterile, non irritant and safe hygienic products, which will add as a successful companion in your surgical operations. We have a wide range of Drapes and Packs suitable for all types of procedures. For confirming sterilization, we attach sterile indicator to each packet of our Drapes and Packs. Please allow us to be your most responsible companion to prevent Hospital Infections.

### **Prophylactic Antibiotics Side effects**

Use of antibiotics leads to - fatal liver damage, Jaundice, Brain, Kidney, Neuro, Cardio vascular, Gastro Intestinal damages, Decreased WBC count, etc. The use of antibiotic combinations have higher risk as the toxicity of one antibiotic will be enhanced by another. Super infection resulting from the use of antibiotics are another danger. Above all the development of micro organisms which are resistant to antibiotics is an International threat.

### **Remember the rule of using antibiotics**

"The first rule of antibiotic is to try not to use them and the second rule is try not to use too many of them"

**Paul L. Marino The ICU Book**





DNV-GL

## EC CERTIFICATE

### Production Quality Assurance

Certificate No.: 202045-2020-43-100-90-PL-Rev. 2.0      Project No.: 2020-106440-2017-PLU-000      Issue Date: 27 February 2021

This is to certify that the quality system of:

**Careon Healthcare Solutions Pvt. Ltd.**  
Kinfra Hi-Tech Biotechnology Park KALAMASSERY, COCHIN- 683503 Kerala, India

For production and final product inspection/testing of:  
**Sterile Disposable Surgeon Gown, Patient Gown, Apron, Surgical drapes, Instrument covers, X ray detectable abdominal pad B.P, X ray detectable Absorbent gauze swab B.P, Umbilical cord clamp and Urine drainage bag**

Has been assessed with respect to:  
**THE CONFORMITY ASSESSMENT PROCEDURE DESCRIBED IN ANNEX V OF COUNCIL DIRECTIVE 93/42/EEC ON MEDICAL DEVICES, AS AMENDED**

and found to comply.

Further details of the product(s) and conditions for certification are given on sheet.

Place and Date:  
Mumbai, 26 April 2021

For:  
DNV GL PREMSYS AS  
Notified Body No.: 2008

Careon Healthcare

The certificate is subject to regular surveillance activities. For details see: [www.dnvgl.com](http://www.dnvgl.com)



DNV-GL

## MANAGEMENT SYSTEM CERTIFICATE

Certificate No.: 202045-2020-43-100-90-PL-Rev. 2.0      Project No.: 2020-106440-2017-PLU-000      Issue Date: 27 February 2021

This is to certify that the management system of:

**Careon Healthcare Solutions Pvt. Ltd.**  
Kinfra Hi-Tech Bio Technology Park, HHT Colony, Kochi - 683503, Kerala, India.

Complies with the requirements of:  
**ISO 13485:2016/NS-EN ISO 13485:2016**

The Certificate is valid for the following scope:  
**Manufacturing & Supply of Sterile Disposable - Surgeons Gown, Patient Gown, Apron, Surgical Drapes, Instrument Covers, X-Ray Detectable Abdominal Pad B.P, X-Ray Detectable Absorbent Gauze Swab B.P, Patient Identification Band, Umbilical Cord Clamp and Urine Drainage Bag.**

Place and Date:  
Mumbai, 27 February 2021

For:  
DNV GL PREMSYS AS

*Espen Wignar Sandberg*  
Espen Wignar Sandberg  
DNV GL

The certificate is subject to regular surveillance activities. For details see: [www.dnvgl.com](http://www.dnvgl.com)



## Certificate of Registration

### 2021

*This is to certify that the registration of*  
**CAREON HEALTHCARE SOLUTIONS PVT LTD**  
KINFRA HITECH BIOTECHNOLOGY PARK, KALAMASSERY, COCHIN  
KERALA, INDIA - 683503

*with U.S. Food and Drug Administration as required by 21 CFR Part 807 is successfully completed by Liberty Management Group Ltd with the information provided by the above company.*

**FEI Number** : 301894829  
**Date of Expiration** : December 31, 2021  
**U.S. Agent** : LIBERTY MANAGEMENT GROUP LTD.  
**Certificate Number** : 3012130120

*This certificate does not make representations or warranties to any person or entity other than the named certificate holder; it is issued for record keeping purposes only. This certificate does not denote endorsement or approval of certificate holder's facility or product by the U.S. Food and Drug Administration. Liberty management Group Ltd assumes no liability to any person or entity in connection with the foregoing.*

*The U.S. Food and Drug Administration does not issue a certificate of registration, nor does the U.S. Food and Drug Administration recognize a certificate of registration. Liberty Management Group Ltd is not affiliated with the U.S. Food and Drug Administration.*

*Mary Zuhra*  
Mary Zuhra  
President  
Liberty Management Group LLC  
Dated: December 13, 2020

**LMG** LIBERTY MANAGEMENT GROUP LTD  
17 Executive Drive, Aurora, Illinois, USA  
[www.libertymg.com](http://www.libertymg.com)

# Sedex®

(SEDEX member & SMETA Compliant Organization)

**ZC: 414089880**  
**ZS: 414101877**

Audit Company Name  
Logo & Reference Number:

**bsi.**  
BSI Group India Pvt. Ltd  
(5VAZC43296917)

# PRODUCT LIST

## A GENERAL CARE PRODUCT

- A/1 Coverall
- A/1 Patient Gown
- A/1 Apron
- A/2 Shoe cover
- A/2 Cling drape
- A/2 Cautery bag
- A/2 Camera cover
- A/3 C-arm cover
- A/3 Microscopic cover
- A/3 Mayo stand cover
- A/4 Instrument trolley sheet
- A/4 Dalthermy bag
- A/4 Cautery bag
- A/5 Fluoroscopic cover
- A/5 Angio protection cover
- A/5 Tube holder W/ Velcro
- A/5 C-arm cover

## B SURGICAL GOWN

- B/1 Surgical gown Standard
- B/1 Overlap gown
- B/1 Overlap reinforced gown
- B/2 Alcohol repellent gown
- B/2 Overlap santora gown
- B/2 Wrap around gown
- B/3 Wrap around reinforced Gown
- B/3 Overlap BVB gown

## C GENERAL SURGICAL SHEETS

- C/1 Trolley Sheet 150 x 200
- C/1 Trolley Sheet 90 x 75
- C/1 Trolley Sheet 75 x 75
- C/1 Trolley Sheet 75 x 50
- C/2 Trolley Sheet 160 x 200
- C/2 Trolley Sheet 160 x 150
- C/2 Trolley Sheet 160 x 100
- C/2 Trolley Sheet 100 x 80
- C/2 Trolley Sheet 80 x 80
- C/3 Trolley Sheet 240 x 240
- C/3 Trolley Sheet 160 x 125
- C/3 Trolley Sheet 160 x 240
- C/3 Trolley Sheet 250 x 160
- C/4 Surgical sheet W/AD 160 x 200
- C/4 Surgical sheet W/AD 160 x 100
- C/4 Surgical sheet W/AD 100 x 80
- C/4 Surgical sheet W/AD 80 x 80
- C/5 Surgical sheet W/AD 30 x 30
- C/5 Surgical sheet W/AD 100 x 160
- C/5 Surgical sheet W/AD 30 x 30
- C/6 Surgical Sheet 80 x 80
- C/6 Surgical Sheet 160 x 150
- C/6 Surgical Sheet 160 x 240
- C/7 Absorbent Sheet 150 x 200
- C/7 Absorbent Sheet 150 x 150
- C/7 Absorbent Sheet 150 x 100
- C/7 Absorbent Sheet 100 x 75
- C/7 Absorbent Sheet 75 x 75
- C/8 Absorbent Sheet W/AD 225 x 150
- C/8 Absorbent Sheet W/AD 150 x 100
- C/8 Absorbent Sheet W/AD 100 x 75
- C/8 Absorbent Sheet W/AD 75 x 75
- C/9 Large sheet W/AD 160 x 200
- C/9 Medium sheet W/AD 160 x 100
- C/9 Small sheet W/AD 100 x 80
- C/9 Extra Small sheet W/AD 80 x 80
- C/10 Surgical Sheet 160 x 225
- C/10 Surgical Sheet 160 x 160
- C/10 Utility Drape 60 x 40
- C/10 Surgical Sheet 125 x 200
- C/11 Surgical Sheet 160 x 200
- C/11 Surgical Sheet 160 x 100
- C/11 Surgical Sheet 100 x 100
- C/11 Surgical Sheet 100 x 80

## D GENERAL SURGERY

- D/1 TOP Drape 100 x 160
- D/1 Side Drape 80 x 80
- D/1 Bottom Drape 160 x 130

- D/2 U- Drape 300 x 160
- D/2 Bar Drape 110 x 240
- D/3 Small Fenestrated Drape 75 x 75
- D/3 Square Fenestrated Drape 300 x 160
- D/3 Transverse Laparotomy Drape 300 x 160
- D/4 Universal Pack I
- D/4 Universal Pack II
- D/5 U-Bar Pack
- D/5 Laparotomy Pack I
- D/6 Transverse Laparotomy Pack II
- D/6 Small Procedure Pack

## E NEUROLOGY

- E/1 Craniotomy Drape 160 x 300
- E/1 Lamino Spinal Drape 300 x 260
- E/2 Craniotomy Pack
- E/2 Lamino Spinal Pack

## F OPHTHALMIC AND ENT

- F/1 Eye Drape 160 x 180
- F/1 Thyroid Drape 160 x 300
- F/1 Dental Drape 140 x 140
- F/1 Fenestrated Drape 80 x 80
- F/2 Ophthalmic Drape 100 x 80
- F/2 Ophthalmic Drape W/Cum Fenestrated 140 x 140
- F/2 Head Drape W/Turban 125 x 110
- F/2 Head Drape with Absorbent Reinforced 110x125
- F/3 ENT split drape 300 x 160
- F/3 Ophthalmic drape 80 x 100
- F/3 Ophthalmic drape 140 x 140
- F/3 Eye Drape 40 x 50
- F/4 Dental Pack
- F/5 Thyroid Pack
- F/6 Eye Pack I
- F/6 Eye pack II
- F/7 Eye Pack III
- F/7 ENT Pack I

## G GYNECOLOGY AND OBSTETRICS

- G/1 Laparoscopy Drape W/Legging
- G/1 Laparoscopy T\* Drape
- G/1 Abdominal Drape
- G/2 Legging
- G/2 Cone shape Legging
- G/2 Cone Shape foot cover
- G/3 Legging Blue Plastic
- G/3 Maternity mat W/ Pouch
- G/3 Maternity Mat W/ fluid collection Pouch
- G/4 10\* cm Open Legging
- G/4 Under buttocks Drape W/Fluid collection Pouch
- G/4 Under buttocks Drape W/Absorbent Pad
- G/5 Lithotomy T\* Drape
- G/5 C-Section Drape
- G/5 C-Section Drape W/Fluid Collection Pouch
- G/6 Large Sheet
- G/6 Medium Sheet
- G/6 Small Sheet
- G/6 Extra Small Sheet
- G/7 Surgical Sheet medium
- G/7 Surgical Sheet
- G/7 Surgical Sheet Small
- G/7 Small Fenestrated Sheet
- G/8 Laparoscopy Pack I
- G/8 Laparoscopy Pack II
- G/9 Caesarian Pack I
- G/9 Caesarian Pack II
- G/10 Caesarian Pack III
- G/10 Caesarian Pack IV
- G/11 Delivery Pack I
- G/11 Delivery Pack II
- G/12 Delivery Pack III
- G/13 Lithotomy Pack I
- G/13 Lithotomy Pack II

## H UROLOGY

- H/1 Cystoscopy T\* Drape
- H/1 TURP Drape W/ Leggings
- H/2 PCNL Drape
- H/2 PCNL Pack
- H/3 Cystoscopy pack
- H/3 TURP Pack

## I CARDIOLOGY

- I/1 Perineal Drape
- I/1 Fenestrated Drape
- I/2 Angio Drape
- I/2 Radial Drape
- I/2 Surgical Sheet W/ Absorbent Reinforcement
- I/3 CABG drape
- I/3 Bilateral under Leg drape
- I/3 Screen Sheet
- I/4 Femoral Drape
- I/4 Femoral Angiography Drape
- I/4 Pace Maker Drape
- I/5 Radial femoral Angiography Drape
- I/5 Radial Drape
- I/5 Femoral Angiography Drape
- I/6 CABG Pack I
- I/7 CABG Pack II
- I/7 Pace maker Pack I
- I/8 Pace maker Pack II
- I/8 Pace maker Pack III
- I/9 Radial Femoral Angiography Pack
- I/9 Femoral Angiography Pack I
- I/10 Femoral Angiography Pack II
- I/10 Femoral Angiography Pack III
- I/11 Perineal Pack I
- I/11 Perineal Pack II
- I/12 Cath Lab Pack
- I/13 Coronary Artery by pass pack

## J ORTHOPEDIC

- J/1 Upper extremity drape
- J/1 Extremity prep pad
- J/1 Impervious Split sheet
- J/2 Bi-lateral Knee-O-Drape
- J/2 Hip Drape W/Fluid collection Pouch
- J/2 DAS Drape Large
- J/3 Arthroscopy Drape
- J/3 Knee Arthroscopy Drape
- J/3 HIP-U Drape
- J/4 Lamino Spinal Drape
- J/4 Split U Drape
- J/5 Ortho U Drape
- J/5 Bar Drape
- J/6 Shoulder Arthroscopy drape
- J/6 Shoulder Arthroscopy lateral
- J/6 Universal Extremity Drape
- J/7 LEG O\* Drape
- J/7 LEG U\* Drape
- J/7 Knee-O\*- Premium
- J/7 Hand Drape W/Arm Board cover
- J/8 Ortho Pack I
- J/8 Ortho Pack II
- J/9 Ortho Pack III
- J/9 Ortho Pack IV
- J/10 HIP Pack
- J/10 Arthroscopy Pack I
- J/11 Arthroscopy Pack II
- J/11 Arthroscopy Pack III
- J/12 Vertical Isolation pack
- J/12 Spinal Pack
- J/13 Universal Extremity pack
- J/13 TKR Pack I
- J/14 TKR Pack II
- J/15 Bi-Lateral Knee Pack
- J/15 Hand Pack
- J/16 Shoulder Arthroscopy Pack I
- J/16 Shoulder Arthroscopy Lateral Pack II

## K GENERAL SURGICAL PRODUCTS

- K/1 Caredrip | Hemocare
- K/1 Endotracheal Tube
- K/1 Lap Sponge Mopping pad
- K/1 Gauze Swab | Cannula Fixator Carefix
- K/1 IV Cannula | Urine Drainage Bag
- K/2 Sterile Pad | Adult Diaper
- K/2 New Born Bay Diaper | Hand Towel
- K/2 Baby Wiper | Nurse's Cap
- K/3 Surgical Clipper | Nebulizer
- K/3 Anaesthesia Mask Adult / Pediatric
- K/3 Cord Clamp | Goggles | ID Band





# General care product

- Professional Apparels
- Patient Care Products
- Head Wear
- Foot Wear
- Equipment Covers

## COVERALL

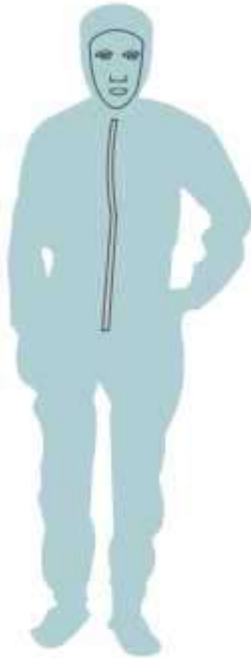

Product Code #	Description	Size(cm)
CR 143027-051 CR 143027-052 CR 143027-053	Coverall	Small Medium Large

## PATIENT GOWN



Product Code #	Description	Size(cm)
CR 143048-002 CR 143048-003 CR 143048-004	Patient Gown	Small Medium Large

## APRON

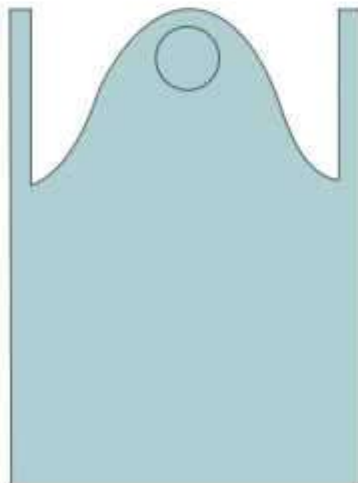

Product Code #	Description	Size(cm)
CR 143005-001 CR 143005-002 CR 143005-003	Apron	Small Medium Large





## SHOE COVER



Product Code #	Description	Size(cm)
CC 142035-006	Shoe Cover <ul style="list-style-type: none"> <li>• Latex Free Elastic</li> <li>• Closure</li> </ul>	70x42

## CLING DRAPE



Product Code #	Description	Size(cm)
CR 143013-000	Cling Drape	000

## CAUTERY BAG

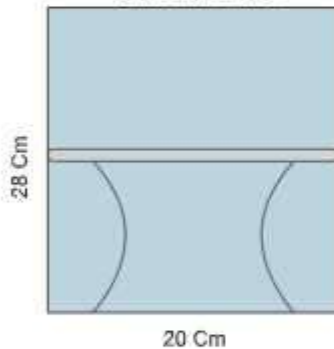

Product Code #	Description	Size(cm)
CC 142002-000	Cautery Bag	28x20

## CAMERA COVER



Product Code #	Description	Size(cm)
CR 143010-002	Camera Cover <ul style="list-style-type: none"> <li>• Card Board Support</li> <li>• Adhesive with Release</li> </ul>	20x240



## C-ARM COVER

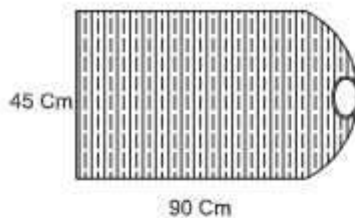

Product Code #	Description	Size(cm)
CC 142001-000	C-Arm Cover <ul style="list-style-type: none"> <li>• Latex free elastic closure</li> </ul>	45x90

## MICROSCOPIC COVER

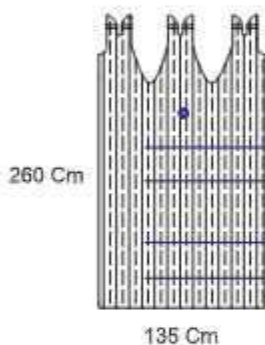

Product Code #	Description	Size(cm)
CC 142028-004	Microscopic Cover <ul style="list-style-type: none"> <li>• With elastomeric Lens fittings</li> <li>• With securing tape</li> <li>• With elastic gathering strap</li> </ul>	135x260

## MAYO STAND COVER

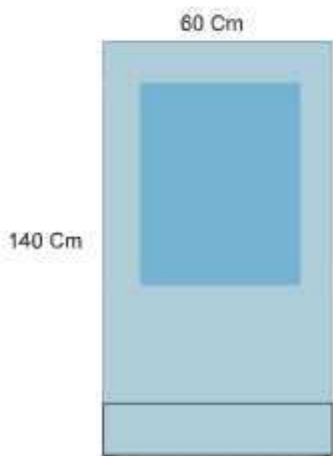

Product Code #	Description	Size(cm)
CR 143039-004	Mayo Stand Cover <ul style="list-style-type: none"> <li>• 50x66 SMS reinforcement</li> </ul>	60x140



**INSTRUMENT TROLLEY SHEET**

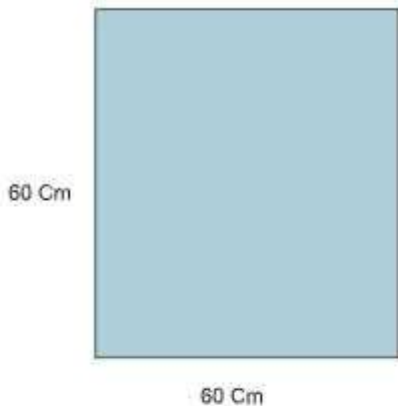

Product Code #	Description	Size(cm)
040-060-060S	Trolley Sheet	60x60

**DAITHERMY BAG**

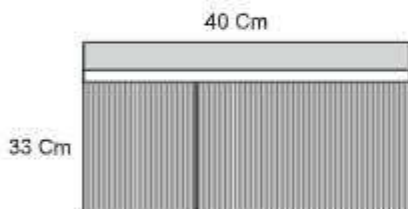

Product Code #	Description	Size(cm)
CC 142002-001	Daithermy Bag • Adhesive	40x33

**CAUTRY BAG**

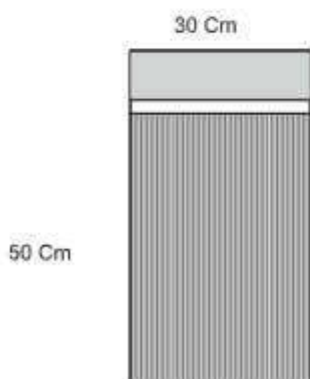

Product Code #	Description	Size(cm)
CC 142002-002	Cautry Bag • Adhesive	30x50





**FLUROSCOPY COVER**

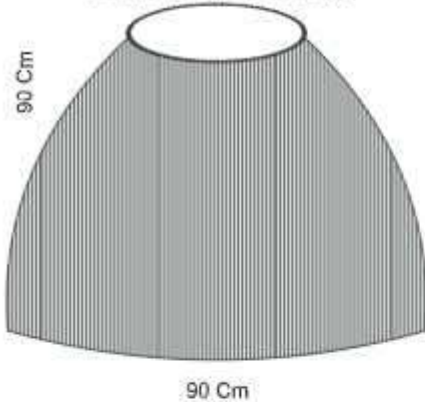

Product Code #	Description	Size(cm)
CC 142014-003	Fluroscopy Cover • Latex Free Elastic • Closure	90x90

**ANGIO PROTECTION COVER**

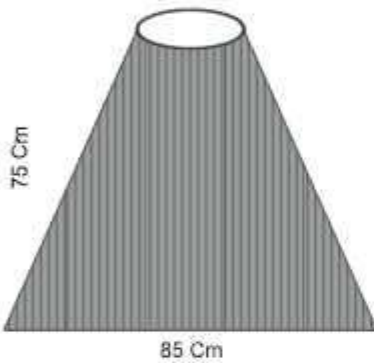

Product Code #	Description	Size(cm)
CC 142014-000	Angio Protection Cover • Latex Free Elastic • Closure	85x75

**TUBE HOLDER WITH VELCRO**

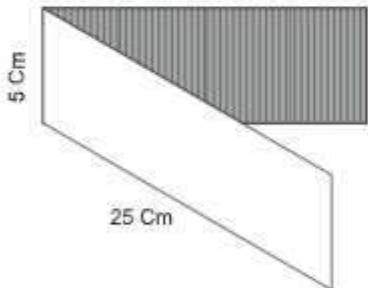

Product Code #	Description	Size(cm)
CR 143086-002	Tube Holder with Velcro • Adhesive • Velcro	5x25

**C-ARM COVER**

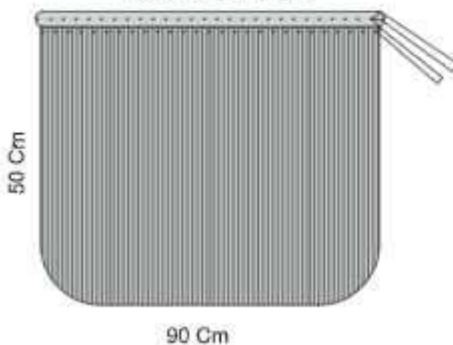

Product Code #	Description	Size(cm)
CC 142001-002	C-Arm Cover • Adhesive • Velcro	50x90





# Surgical gown

- **Standard Gowns**
- **Overlap Gowns**
- **Wrap around Gowns**
- **Alcohol Repellent Gown**
- **Speciality Gowns BVB**
- **Other Gowns**

# SURGICAL GOWN

Level - II

## SURGICAL GOWN (STANDARD)



Product Code #	Description	Size(cm)
CR 143027-024 CR 143027-025 CR 143027-026	Surgical Gown (Standard)	Small Medium Large

## SURGICAL GOWN (OVERLAP)

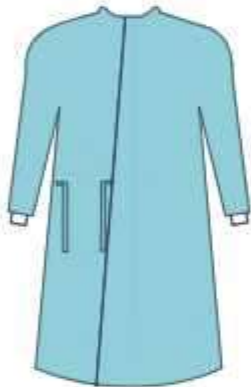

Product Code #	Description	Size(cm)
CR 143027-027 CR 143027-028 CR 143027-029	Overlap Gown	Small Medium Large

## SURGICAL GOWN (OVERLAP REINFORCED)



Product Code #	Description	Size(cm)
CR 143027-030 CR 143027-031 CR 143027-032	Overlap Reinforced Gown	Small Medium Large





# SURGICAL GOWN

Level - III

## SURGICAL GOWN (ALCOHOL REPELLENT)



Product Code #	Description	Size(cm)
CR 143027-045 CR 143027-046 CR 143027-047	Surgical Gown (Alcohol Repellent)	Small Medium Large

## SURGICAL GOWN (OVERLAP SONTORA)



Product Code #	Description	Size(cm)
CR 143027-046 CR 143027-047 CR 143027-048	Surgical Gown (Overlap Sontora)	Small Medium Large

## SURGICAL GOWN (WRAP AROUND)

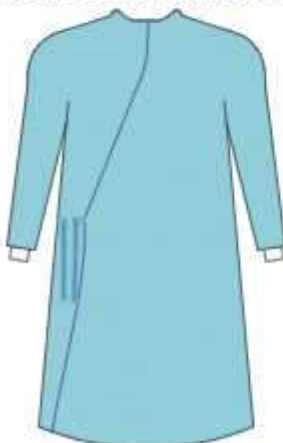

Product Code #	Description	Size(cm)
CR 143027-038 CR 143027-039 CR 143027-040	Surgical Gown (Wrap Around)	Small Medium Large



## SURGICAL GOWN (WRAP AROUND REINFORCED)



Product Code #	Description	Size(cm)
CR 143027-044 CR 143027-045 CR 143027-046	Surgical Gown (Wrap Around Reinforced)	Small Medium Large

## SURGICAL GOWN (OVERLAP BVB)



Product Code #	Description	Size(cm)
CR 143027-047 CR 143027-048 CR 143027-049	Surgical Gown (Overlap BVB)	Small Medium Large





# General Surgical Sheets

- Trolley Sheets
- Surgical Sheets
- Absorbent Sheets



TROLLEY SHEET

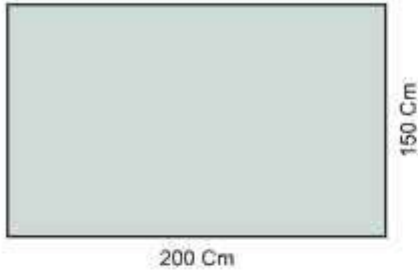

Product Code #	Description	Size(cm)
318-200-150S	Trolley Sheet	150x200

TROLLEY SHEET

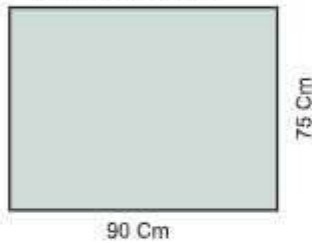

Product Code #	Description	Size(cm)
318-90-075S	Trolley Sheet	90x75

TROLLEY SHEET

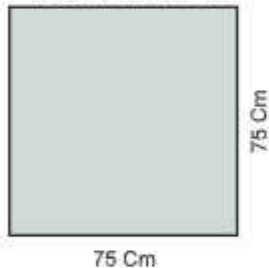

Product Code #	Description	Size(cm)
318-75-075S	Trolley Sheet	75x75

TROLLEY SHEET

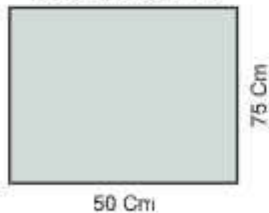

Product Code #	Description	Size(cm)
318-50-075S	Trolley Sheet	75x50



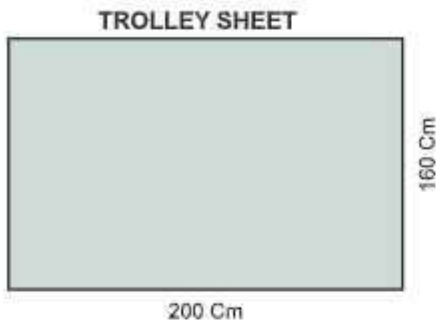

Product Code #	Description	Size(cm)
318-160-200S	Trolley Sheet	200x160

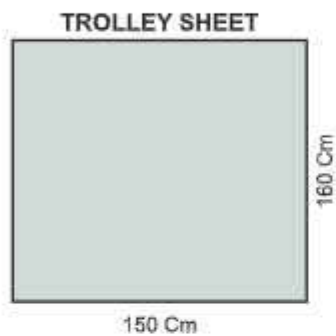

Product Code #	Description	Size(cm)
318-160-150S	Trolley Sheet	160x150

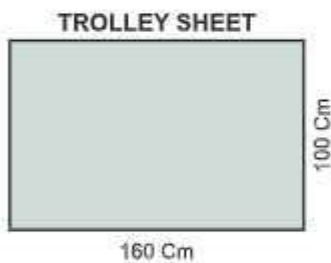

Product Code #	Description	Size(cm)
085-160-100S	Trolley Sheet	160x100

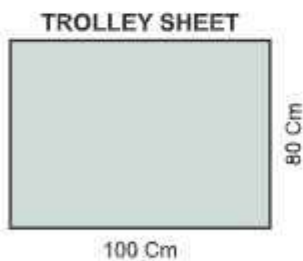

Product Code #	Description	Size(cm)
318-80-100S	Trolley Sheet	100x80

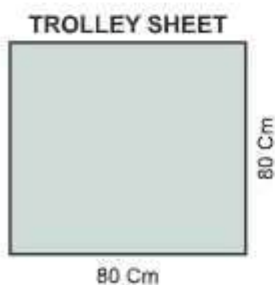

Product Code #	Description	Size(cm)
318-80-080S	Trolley Sheet	80x80



TROLLEY SHEET

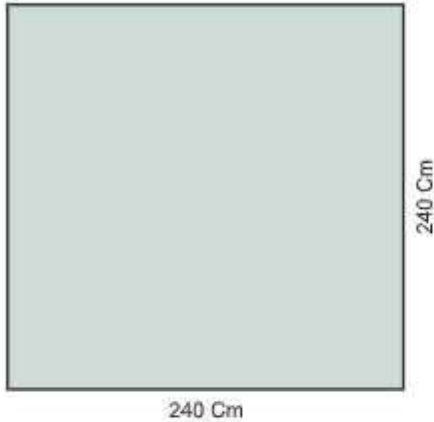

Product Code #	Description	Size(cm)
318-240-240S	Trolley Sheet	240x240

TROLLEY SHEET

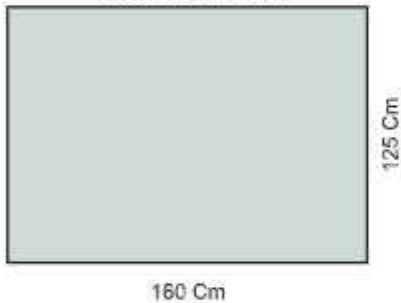

Product Code #	Description	Size(cm)
085-160-125S	Trolley Sheet	160x125

TROLLEY SHEET

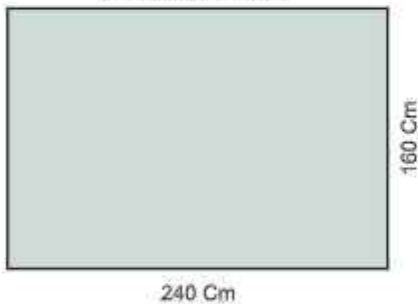

Product Code #	Description	Size(cm)
318-160-240S	Trolley Sheet	240x160

TROLLEY SHEET

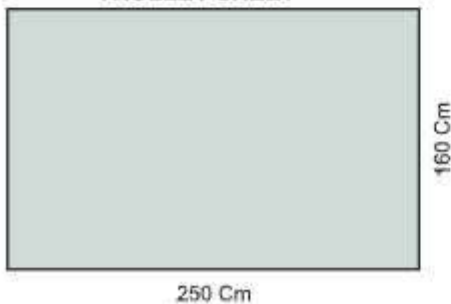

Product Code #	Description	Size(cm)
085-160-250S	Trolley Sheet	250x160



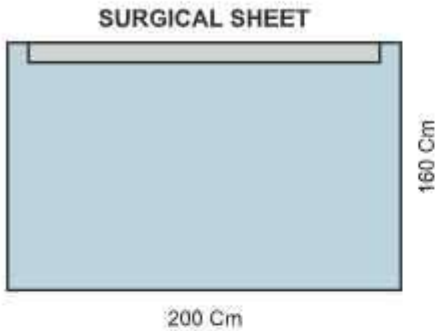

Product Code #	Description	Size(cm)
043-160-200A	Surgical Sheet • Adhesive	160x200

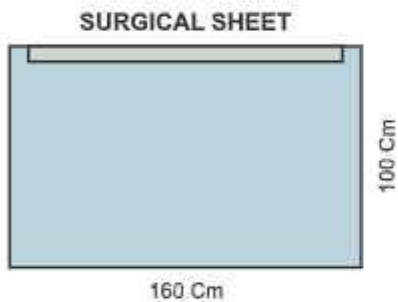

Product Code #	Description	Size(cm)
043-160-100A	Surgical Sheet • Adhesive	160x100

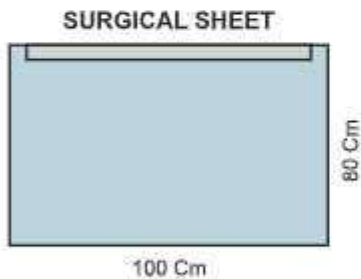

Product Code #	Description	Size(cm)
043-080-100A	Surgical Sheet • Adhesive	100x80

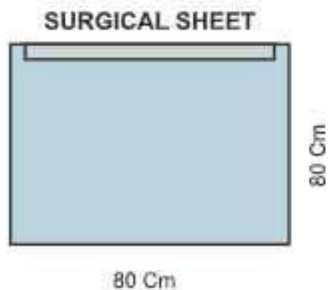

Product Code #	Description	Size(cm)
043-080-080A	Surgical Sheet • Adhesive	80x80





# DRAPE WITH ADHESIVE GENERAL SURGICAL SHEET

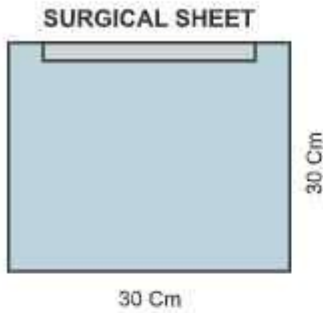

Product Code #	Description	Size(cm)
043-030-030A	Surgical Sheet • Adhesive	30x30

## MEDIUM DRAPE WITH ADHESIVE

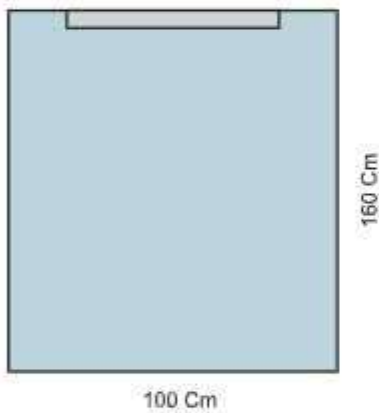

Product Code #	Description	Size(cm)
043-160-100A	Medium Drape with Adhesive • Adhesive	100x160

## DURAL TOWEL DRAPE

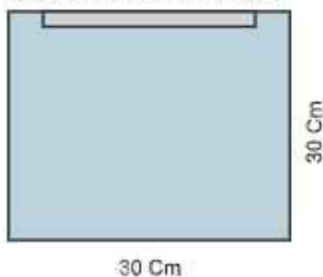

Product Code #	Description	Size(cm)
043-030-030A	Dural Towel Drape • Adhesive	30x30



# SURGICAL PLAIN SHEET

## GENERAL SURGICAL SHEET

SURGICAL SHEET

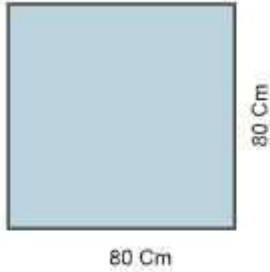

Product Code #	Description	Size(cm)
043-080-080S	Surgical Sheet	80x80

SURGICAL SHEET

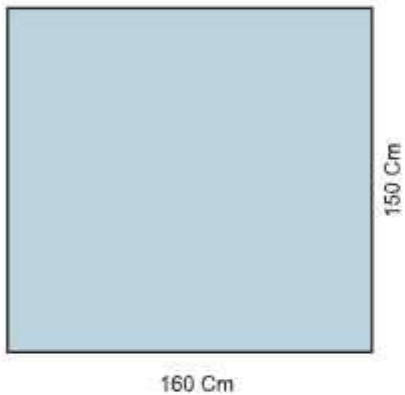

Product Code #	Description	Size(cm)
043-160-150S	Surgical Sheet	160x150

LAMINATED ABSORBENT SHEET

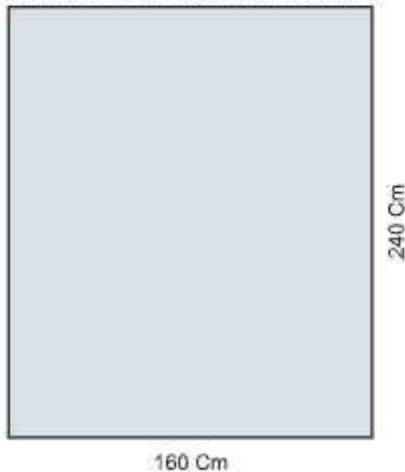

Product Code #	Description	Size(cm)
060-160-240S	Laminated Absorbent Sheet	160x240



# PLAIN SHEET ABSORBENT GENERAL SURGICAL SHEET

ABSORBENT SHEET

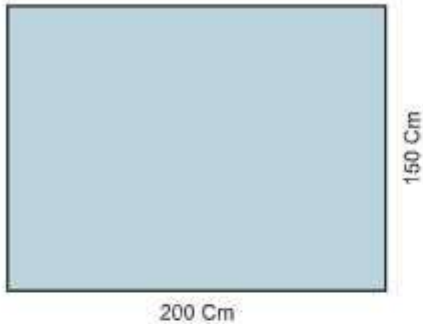

Product Code #	Description	Size(cm)
065-150-200S	Absorbent Sheet	150x200

ABSORBENT SHEET

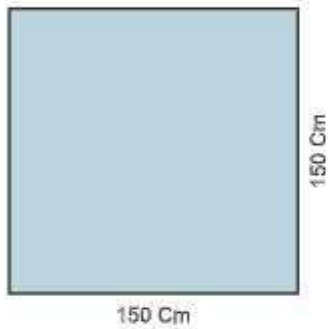

Product Code #	Description	Size(cm)
065-150-150S	Absorbent Sheet	150x150

ABSORBENT SHEET



Product Code #	Description	Size(cm)
065-150-100S	Absorbent Sheet	150x100

ABSORBENT SHEET

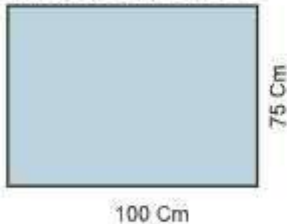

Product Code #	Description	Size(cm)
065-100-075S	Absorbent Sheet	100x75

ABSORBENT SHEET

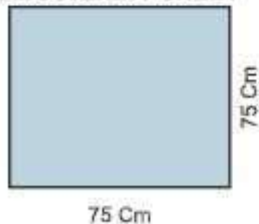

Product Code #	Description	Size(cm)
065-75-075S	Absorbent Sheet	75x75



**FENESTRATED ABSORBENT SHEET**

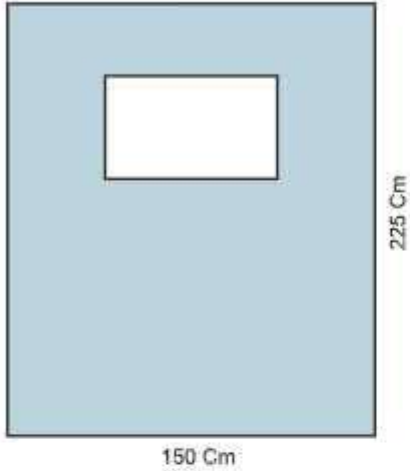

Product Code #	Description	Size(cm)
065-150-225S	Fenestrated Absorbent Sheet • 15x25 Cm Fenestration	225x150

**ABSORBENT SHEET**

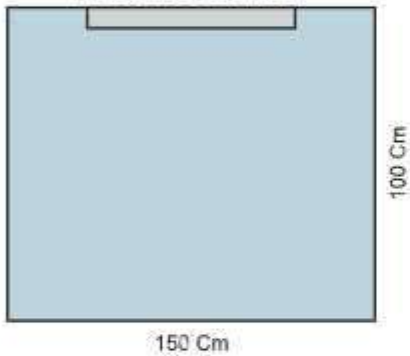

Product Code #	Description	Size(cm)
065-150-100A	Absorbent Sheet • Adhesive	150x100

**ABSORBENT SHEET**

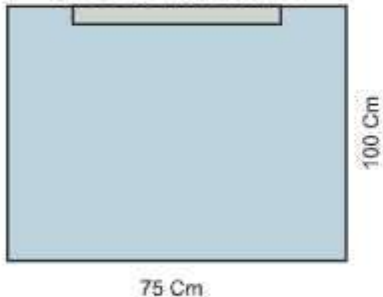

Product Code #	Description	Size(cm)
065-100-075A	Absorbent Sheet • Adhesive	100x75

**ABSORBENT SHEET**

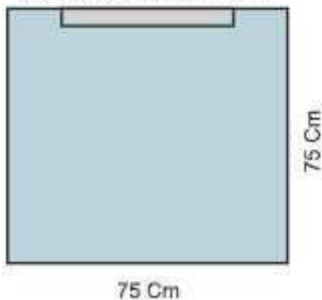

Product Code #	Description	Size(cm)
065-075-075A	Absorbent Sheet • Adhesive	75x75





# DRAPE WITH ADHESIVE

## UNIVERSAL / MULTI - PROCEDURAL DRAPE

LARGE SHEET

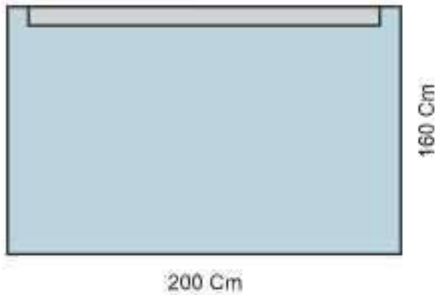

Product Code #	Description	Size(cm)
043-160-200A	Large Sheet • Adhesive	160x200

MEDIUM SHEET

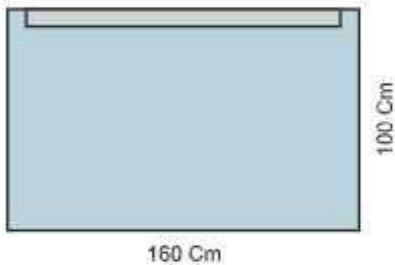

Product Code #	Description	Size(cm)
043-160-100A	Medium Sheet • Adhesive	160x100

SMALL SHEET

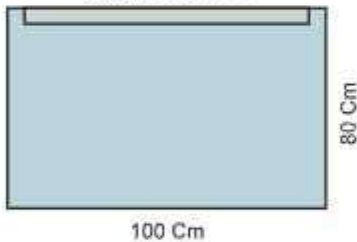

Product Code #	Description	Size(cm)
043-080-100A	Small Sheet • Adhesive	100x80

EXTRA SMALL SHEET

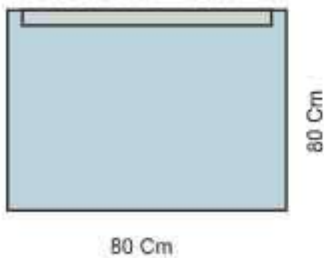

Product Code #	Description	Size(cm)
043-080-080A	Extra Small Sheet • Adhesive	80x80



# DRAPE WITH ADHESIVE GENERAL SURGERY SHEET

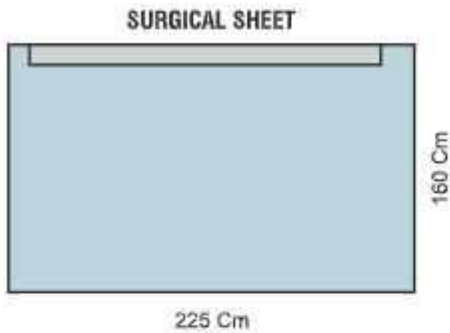

Product Code #	Description	Size(cm)
043-160-225A	Surgical Sheet • Adhesive	160x225

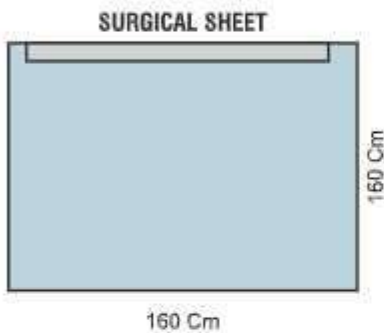

Product Code #	Description	Size(cm)
043-160-160A	Surgical Sheet • Adhesive	160x160

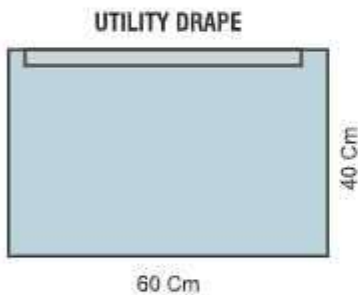

Product Code #	Description	Size(cm)
043-060-040A	Utility Drape *Adhesive	60x40

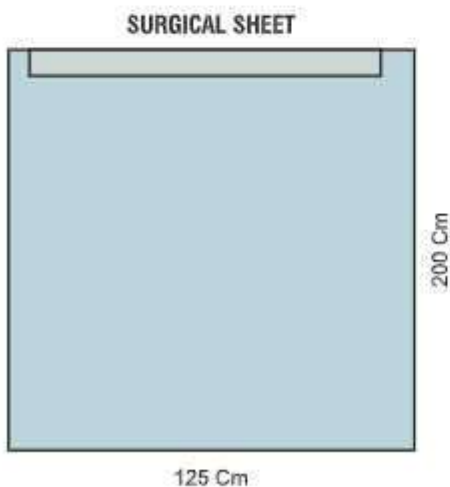

Product Code #	Description	Size(cm)
043-125-200A	Small Sheet • Adhesive	125x200



# SURGICAL PLAIN SHEET

## GENERAL SURGERY SHEET

SURGICAL SHEET

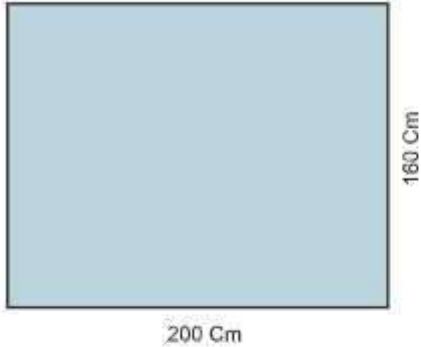

Product Code #	Description	Size(cm)
043-160-200S	Surgical Sheet	160x200

SURGICAL SHEET

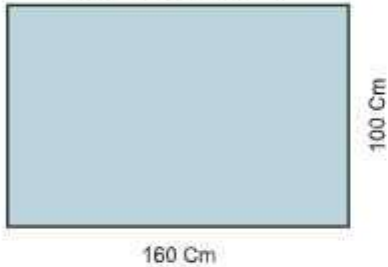

Product Code #	Description	Size(cm)
043-160-100S	Surgical Sheet	160x100

SURGICAL SHEET

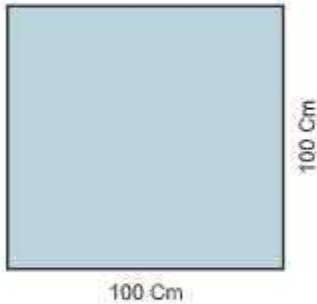

Product Code #	Description	Size(cm)
043-100-100S	Surgical Sheet	100x100

SURGICAL SHEET

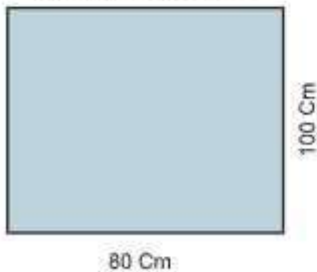

Product Code #	Description	Size(cm)
043-080-100S	Surgical Sheet	100x80





# General Surgery Packs & Drapes

- **Single Drapes**
- **Universal Packs**
- **U-Bar Packs**
- **Laparotomy Packs**
- **Laparoscopic Packs**



## DRAPE WITH REINFORCED AND ADHESIVE

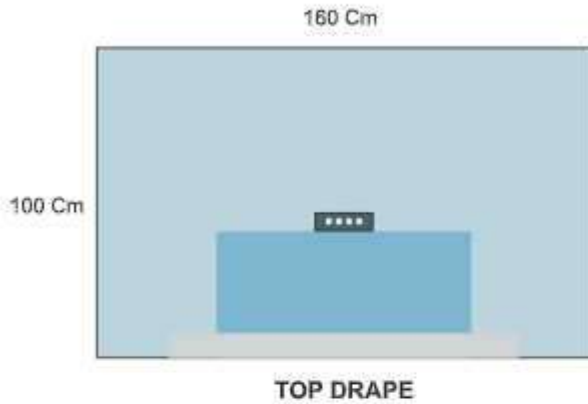

Product Code #	Description	Size(cm)
40011-0000	Top Drape <ul style="list-style-type: none"> <li>• Absorbent Laminated reinforcement</li> <li>• Tube holder</li> <li>• Adhesive</li> </ul>	100x160

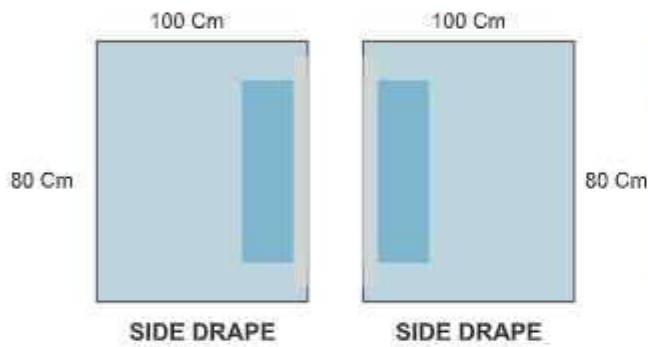

Product Code #	Description	Size(cm)
40012-0000	Side Drape <ul style="list-style-type: none"> <li>• Absorbent Laminated reinforcement</li> <li>• Adhesive</li> </ul>	80x100

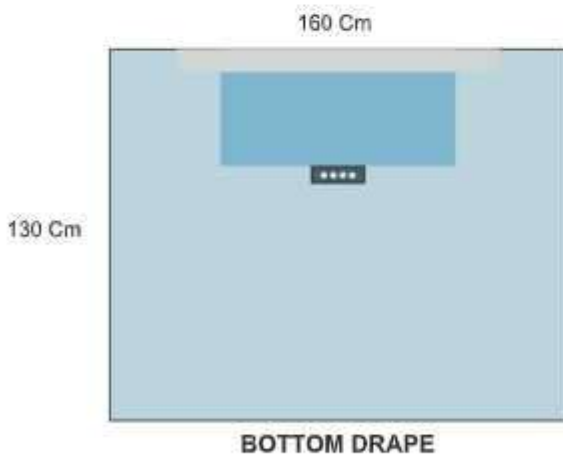

Product Code #	Description	Size(cm)
40013-0000	Bottom Drape <ul style="list-style-type: none"> <li>• Absorbent Laminated reinforcement</li> <li>• Tube holder</li> <li>• Adhesive</li> </ul>	160x130



**U-DRAPE**

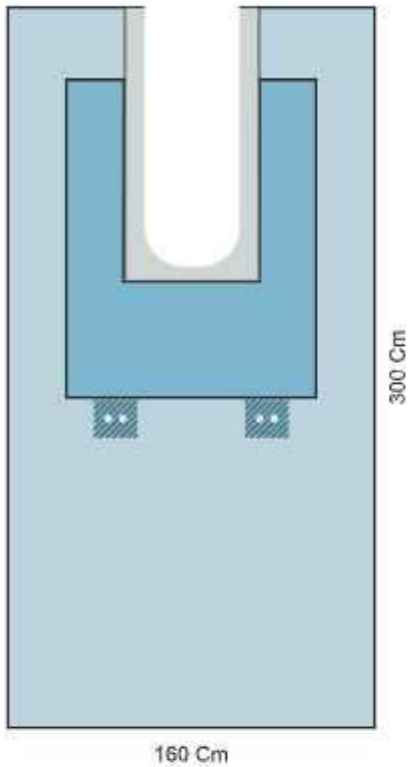

Product Code #	Description	Size(cm)
41011-0000	U-Drape <ul style="list-style-type: none"> <li>• Adhesive</li> <li>• Absorbent Laminated Reinforcement</li> <li>• Tube Holder</li> <li>• 10x100 Cm Spit</li> </ul>	300x160

**BAR DRAPE**

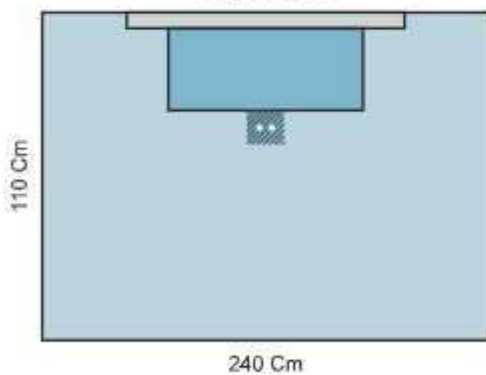

Product Code #	Description	Size(cm)
41012-0000	Bar Drape <ul style="list-style-type: none"> <li>• Adhesive</li> <li>• Absorbent Laminated Reinforcement</li> <li>• Tube Holder</li> </ul>	110x240

160 Cm



## SMALL FENESTRATED DRAPE

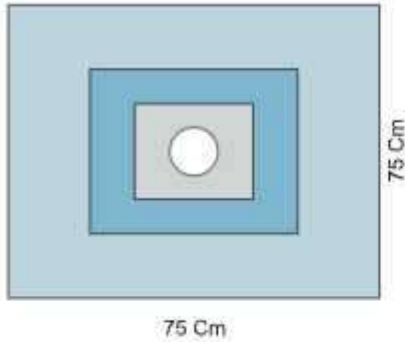

Product Code #	Description	Size(cm)
41101-0000	Small Fenestrated Drape <ul style="list-style-type: none"> <li>• Adhesive</li> <li>• Absorbent Laminated Reinforcement</li> <li>• 6 Cm Circular Fenestration</li> </ul>	75x75

## SQUARE FENESTRATED DRAPE

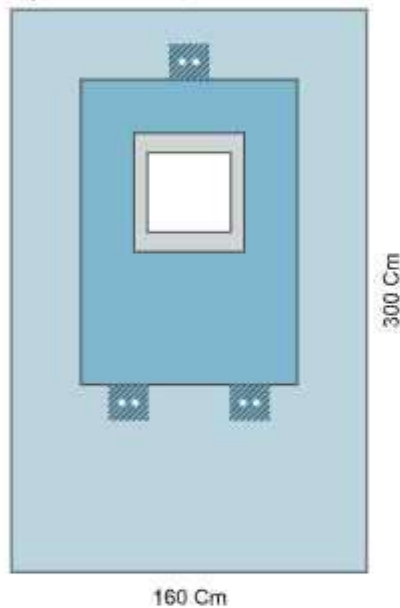

Product Code #	Description	Size(cm)
41201-0000	Square Fenestrated Drape <ul style="list-style-type: none"> <li>• 25 Cm Fenestration</li> <li>• Adhesive</li> <li>• Absorbent Laminated Reinforcement</li> <li>• Tube Holder</li> </ul>	300x160

## TRANSVERSE LAPAROTOMY DRAPE

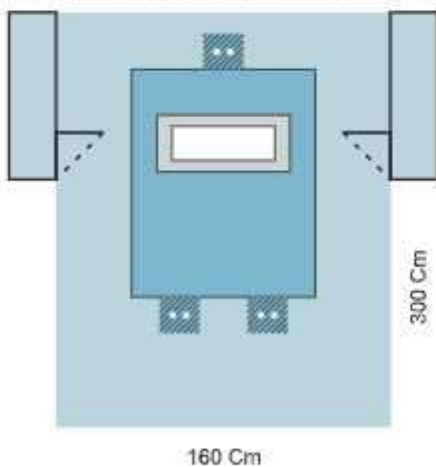

Product Code #	Description	Size(cm)
41202-0000	Transverse Laparotomy Drape <ul style="list-style-type: none"> <li>• 10x30 Cm Fenestration</li> <li>• Absorbent Laminated Reinforcement</li> <li>• Tube Holder</li> <li>• Arm Board Covers</li> </ul>	300x160



## Universal Pack I : Product Code - #66805-0001

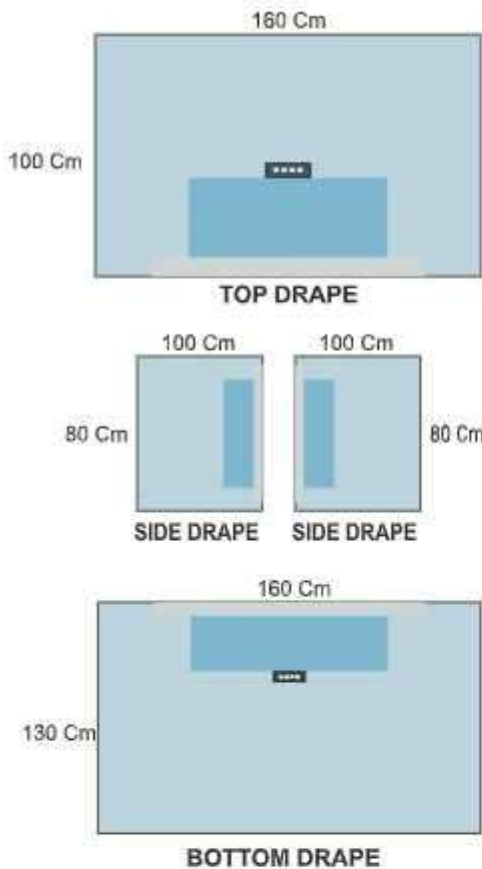

Item Code	Qty.	Contents	Size(cm)
085-160-100S	1 PC	Back Table Cover Reinforced	160x100
CR 143029-000	3 PCS	Hand Towel	30x30
CR 143027-003	3 PCS	Surgical Gown Reinforced/GS14	L
318-160-160S	1 PC	Trolley Sheet Non Woven Laminated	160x160
40011-0000	2 PCS	Top Drape	160x100
		<ul style="list-style-type: none"> <li>• Adhesive</li> <li>• Absorbent Laminated Reinforcement</li> <li>• Tube Holder</li> </ul>	
043-160-200A	2 PCS	X Large Sheet	160x200
		<ul style="list-style-type: none"> <li>• Adhesive</li> </ul>	
CC 142002-002	1 PC	Cautery Bag	35x30
		<ul style="list-style-type: none"> <li>• Adhesive</li> </ul>	
CR 143041-012	6 PCS	Mopping Pad	30x30
043-060-040A	4 PCS	Utility Drape	60x40
		<ul style="list-style-type: none"> <li>• Adhesive</li> </ul>	
CR 143039-004	1 PC	Mayo Stand Cover	60x140
40013-0000	1 PC	Bottom Drape	130x160
		<ul style="list-style-type: none"> <li>• Adhesive</li> <li>• Absorbent Laminated Reinforcement</li> <li>• Tube Holder</li> </ul>	
40012-0000	2 PCS	Side Drape	100x80
		<ul style="list-style-type: none"> <li>• Adhesive</li> <li>• Absorbent Laminated Reinforcement</li> </ul>	
CP 141066-000	1 PC	Carry Bag	

## Universal Pack II : Product Code - #66805-0002

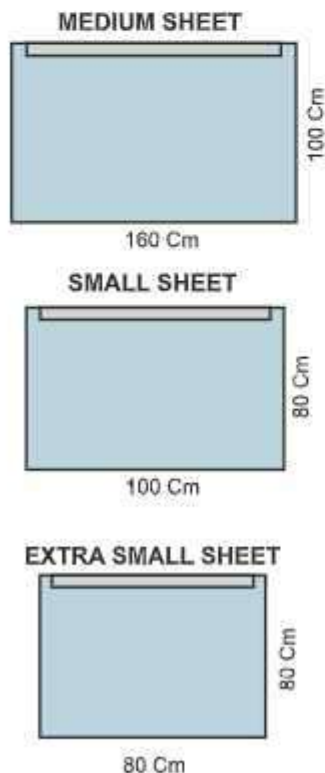

Item Code	Qty.	Contents	Size(cm)
085-160-100S	1 PC	Back Table Cover Reinforced	160x100
CR 143027-024	3 PCS	Surgical Gown	L
CR 143029-000	3 PCS	Hand Towel	30x30
CR 143084-001	1 PC	Under Pad	L
CR 143005-001	1 PC	Apron	L
CR 143039-000	1 PC	Mayo Stand Cover	80x80
043-160-100S	1 PC	Plain Sheet	160x100
065-150-100S	2 PC	Absorbent Sheet	150x100
065-075-100A	2 PC	Absorbent Sheet with Adhesive	75x100
065-150-225S	1 PC	Fenestrated Absorbent Sheet	150x225
		<ul style="list-style-type: none"> <li>• 15x25 Cm Fenestration</li> </ul>	
CR 143041-012	6 PC	Mopping Pad	30x30
CR 143263-002	1 PC	ISO Seal Drape Tape Strips	20x5
CC 142002-002	1 PC	Cautery Bag	35x30
		<ul style="list-style-type: none"> <li>• Adhesive</li> </ul>	
043-160-100A	1 PC	Medium Sheet	160x100
		<ul style="list-style-type: none"> <li>• Adhesive</li> </ul>	
043-080-100A	1 PC	Small Sheet	100x80
		<ul style="list-style-type: none"> <li>• Adhesive</li> </ul>	
043-080-080A	2 PC	Extra Small Sheet	80x80
		<ul style="list-style-type: none"> <li>• Adhesive</li> </ul>	
CP 141066-000	1 PC	Carry Bag	





## U-Bar Pack : Product Code - #66422-0000

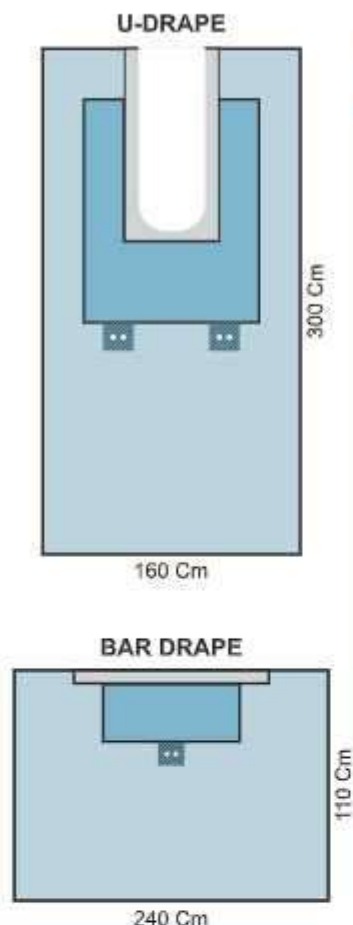

Item Code	Qty.	Contents	Size(cm)
085-160-100S	1 PC	Back Table Cover Reinforced	160x100
CR 143029-000	3 PCS	Hand Towel	30x30
CR 143027-003	3 PCS	Surgical Gown Reinforced/GS14	L
318-160-160S	1 PC	Trolley Sheet Non Woven Laminated	160x160
41011-0000	2 PCS	U-Drape <ul style="list-style-type: none"> <li>• Adhesive</li> <li>• Absorbent Laminated Reinforcement</li> <li>• Tube Holder</li> </ul>	160x300
043-160-200A	2 PCS	X Large Sheet <ul style="list-style-type: none"> <li>• Adhesive</li> </ul>	160x200
CC 142002-000	1 PC	Cautery Bag <ul style="list-style-type: none"> <li>• Adhesive</li> </ul>	35x30
CR 143041-012	6 PCS	Mopping Pad	30x30
043-060-040A	4 PCS	Utility Drape <ul style="list-style-type: none"> <li>• Adhesive</li> </ul>	60x40
CR 143039-000	1 PC	Mayo Stand Cover	80x80
41012-0000	1 PC	Bar Drape <ul style="list-style-type: none"> <li>• Adhesive</li> <li>• Absorbent Laminated Reinforcement</li> <li>• Tube Holder</li> </ul>	110x240
CP 141066-000	1 PC	Carry Bag	

## Laparotomy Pack I : Product Code - #66421-0001

### SQUARE FENESTRATED DRAPE

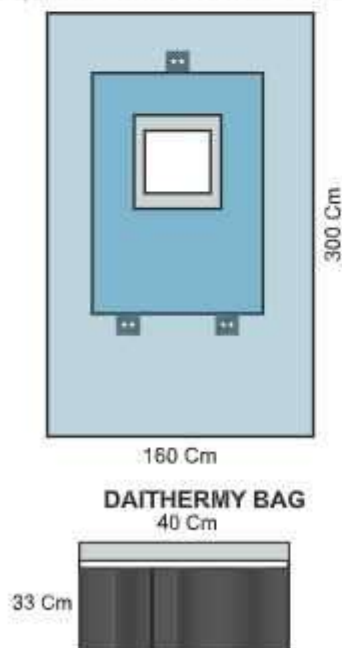

Item Code	Qty.	Contents	Size(cm)
085-160-100S	1 PC	Back Table Cover Reinforced	160x100
CR 143027-024	2 PCS	Surgical Gown	L
CR 143029-000	2 PCS	Hand Towel	30x30
CR 143039-000	1 PC	Mayo Stand Cover	80x80
CR 143029-000	1 PC	Hand Towel	30x30
043-060-040A	4 PCS	Utility Drape <ul style="list-style-type: none"> <li>• Adhesive</li> </ul>	60x40
CR 142002-001	1 PC	Diathermy Bag <ul style="list-style-type: none"> <li>• Adhesive</li> </ul>	35x30
CR 143041-012	4 PC	Mopping Pad	30x30
CR 143005-001	2 PCS	Apron	L
CR 141201-0000	1 PC	Square Fenestrated Drape <ul style="list-style-type: none"> <li>• 25 Cm Fenestration</li> <li>• Adhesive</li> <li>• Absorbent Laminated Reinforcement</li> <li>• Tube Holder</li> </ul>	300x160
CP 141066-000	1 PC	Carry Bag	



## Transverse Laparotomy Pack II : Product Code - #66421-0002

TRANSVERSE LAPAROTOMY DRAPE

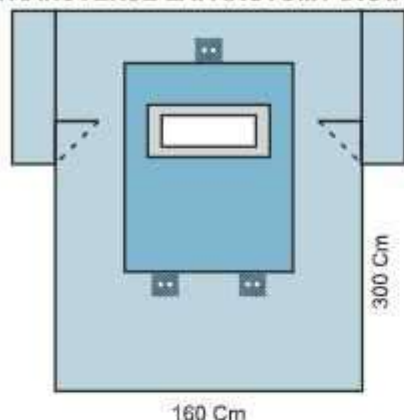

DAITHERMY BAG

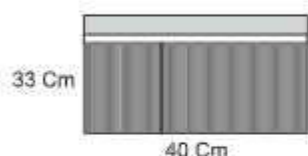

Item Code	Qty.	Contents	Size(cm)
085-160-100S	1 PC	Back Table Cover Reinforced	160x100
CR 143027-030	2 PCS	Surgical Gown Reinforced	L
CR 143029-000	2 PCS	Hand Towel	30x30
CR 143039-000	1 PC	Mayo Stand Cover	80x80
043-060-040A	4 PCS	Utility Drape	60x40
CP 142002-001	1 PC	Diathermy Bag	35x30
CR 143263-002	2 PCS	ISO Seal Drape Tape Strips	20x5
CR 143041-012	4 PC	Mopping Pad	30x30
CR 143005-001	2 PCS	Apron	L
41202-0000	1 PC	Transverse Laparotomy Drape	300x160
		<ul style="list-style-type: none"> <li>• Adhesive</li> <li>• Control Plus Fabric Reinforcement</li> <li>• Tube Holder</li> <li>• Arm Board Covers</li> <li>• 10x30 Cm Fenestration</li> </ul>	
CP 141066-000	1 PC	Carry Bag	

## Small Procedure Pack : Product Code - #66571-0000

SMALL FENESTRATED DRAPE

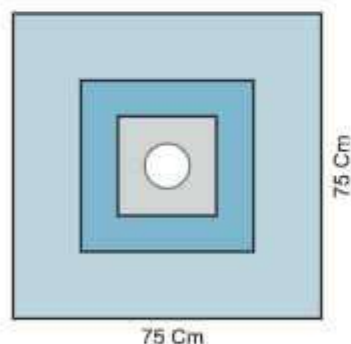

DAITHERMY BAG

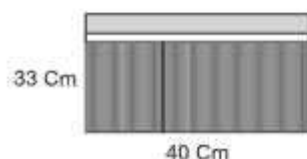

Item Code	Qty.	Contents	Size(cm)
085-160-100S	1 PC	Back Table Cover Reinforced	160x100
CR 143027-024	2 PCS	Surgical Gown	L
CR 143029-000	2 PCS	Hand Towel	30x30
CR 1430263-002	1 PC	ISO Seal Drape Tape Strips	5x20
CR 142002-001	1 PC	Diathermy Bag	35x30
41101-0000	1 PC	Small Fenestrated Drape	75x75
		<ul style="list-style-type: none"> <li>• 6 Cm Circle Fenestration</li> <li>• Adhesive</li> <li>• Absorbent Laminated Reinforcement</li> </ul>	
CP 141066	1 PC	Carry Bag	







# Neurology Packs & Draps

- **Single Drapes**
- **Craniotomy Packs**
- **Lamino Spinal Packs**

## CRANIOTOMY DRAPE

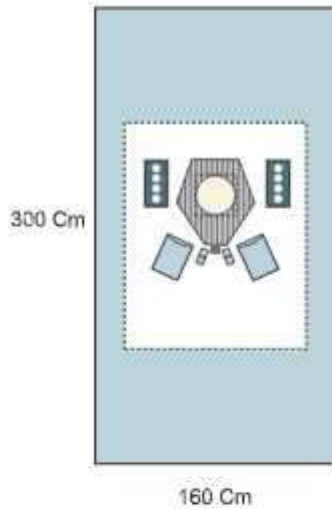

Product Code #	Description	Size(cm)
30262-0000	Craniotomy Drape <ul style="list-style-type: none"> <li>• Hygiene Sheet</li> <li>• Tube holder</li> <li>• Fluid Collection Pouch</li> <li>• Adhesive</li> <li>• Incise</li> <li>• Pockets</li> </ul>	160x300

## LAMINAL SPINAL DRAPE

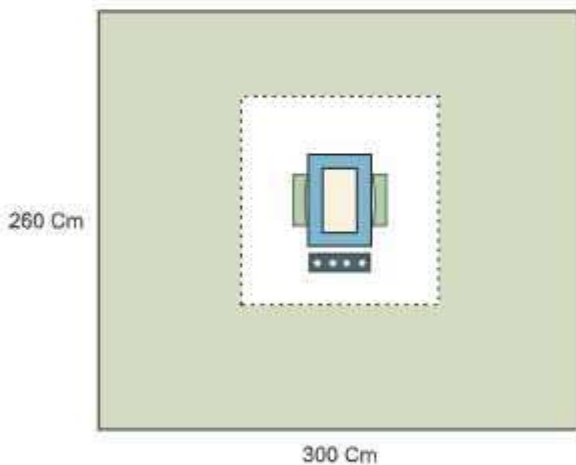

Product Code #	Description	Size(cm)
30251-0000	Laminar Spinal Drape Santara <ul style="list-style-type: none"> <li>• Absorbent Laminated Reinforcement</li> <li>• Hygiene Sheet</li> <li>• Tube holder</li> <li>• Incise</li> <li>• Pockets</li> </ul>	300x260





## Craniotomy Pack : Product Code - #66301-0000

### CRANIOTOMY DRAPE

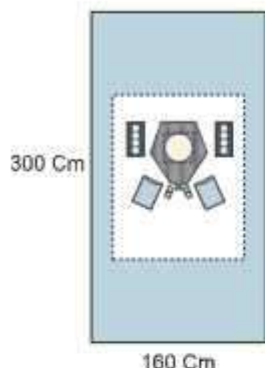

### DURAL TOWEL DRAPE

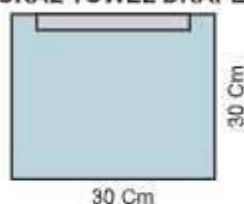

Item Code	Qty.	Contents	Size(cm)
318-160-180S	1 PC	Back Table Cover Reinforced	160x180
085-160-250S	1 PC	Trolley Sheet Laminated Reinforcement	160x250
CR 143027-038	3 PCS	Wrap Around Surgical Gown	L
CR 143029-000	6 PCS	Hand Towels	30x30
043-080-080A	4 PCS	Surgical Sheet with Adhesive	80x80
		• Adhesive	
		• Absorbent Laminated Reinforcement	75x75
043-125-200A	1 PC	Surgical Sheet with Adhesive	125x200
		• Adhesive	
043-030-030A	4 PCS	Dural Towel with Adhesive	30x30
		• Adhesive	
043-160-150S	2 PCS	Surgical Sheet	150x160
043-160-200S	1 PC	Surgical Sheet Large	160x200
30262-0000	1 PC	Craniotomy Drape with Fluid Collection Pouch	160x300
		• Hygiene Sheet	
		• 22 Cm Circular Fenestration	
		• Fluid Collection Pouch	
		• Table Holder	
		• Incise	
CP 141066-000	1 PC	Carry Bag	

## Lamino Spinal Pack : Product Code - #66803-0000

### LAMINAL SPINAL DRAPE

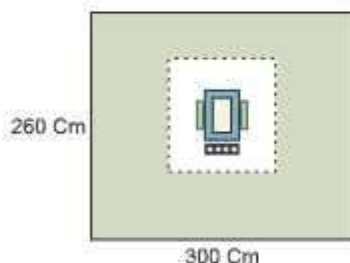

### SURGICAL SHEET

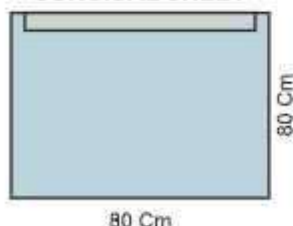

Item Code	Qty.	Contents	Size(cm)
318-160-180S	1 PC	Back Table Cover Reinforced	160x180
CR 143027-038	3 PCS	Wrap Around Surgical Gown	L
CR 143029-000	6 PCS	Hand Towels	30x30
085-160-250S	2 PCS	Trolley Sheet	160x250
043-160-125A	2 PCS	Surgical Sheet with Adhesive	160x125
		• Adhesive	
043-080-080A	4 PC	Surgical Sheet with Adhesive	80x80
		• Adhesive	
043-160-150S	2 PCS	Surgical Sheet Large	150x160
043-160-200S	1 PC	Surgical Sheet Large	160x200
30251-0000L	1 PC	Lamino Spiral Drape Santara	260x300
		• 36x17 Cm Fenestration	
		• Hygiene Sheet	
		• Absorbent Laminated Reinforcement	
		• Incise	
		• Tube Holder	
CP 141066-000	1 PC	Carry Bag	





# Ophthalmic & ENT Packs & Drapes

- **Single Drapes**
- **Dental Packs**
- **Thyroid Packs**
- **Eye Packs**
- **ENT Packs**

**EYE DRAPE**

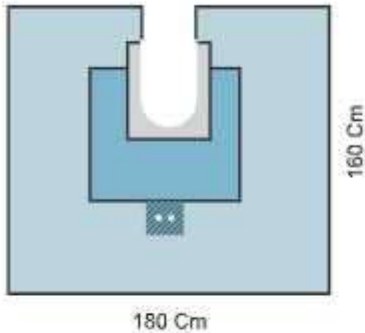

Product Code #	Description	Size(cm)
30213-0000	Eye Drape <ul style="list-style-type: none"> <li>• Adhesive</li> <li>• Absorbent Laminated Reinforcement</li> <li>• 8x58 Cm Split</li> <li>• Tube holder</li> </ul>	160x180

**THYROID DRAPE**

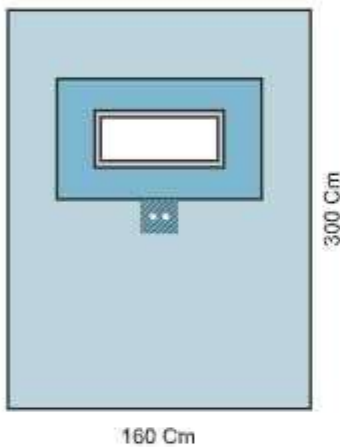

Product Code #	Description	Size(cm)
30312-0000	Thyroid Drape <ul style="list-style-type: none"> <li>• Adhesive</li> <li>• Absorbent Laminated Reinforcement</li> <li>• 8x20 Cm fenestration</li> <li>• Tube Holder</li> </ul>	160x300

**DENTAL DRAPE**

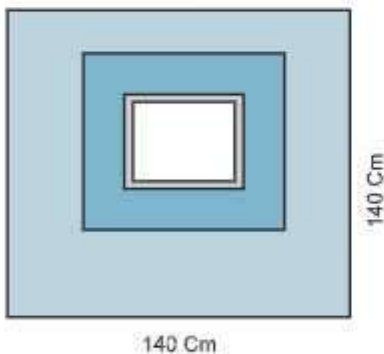

Product Code #	Description	Size(cm)
40101-0000	Dental Drape <ul style="list-style-type: none"> <li>• Adhesive</li> <li>• Absorbent Laminated Reinforcement</li> <li>• 12x12 Cm Fenestration</li> </ul>	140x140

**FENESTRATED DRAPE**

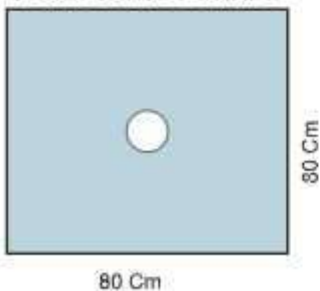

Product Code #	Description	Size(cm)
043-080-080S	Fenestrated Drape <ul style="list-style-type: none"> <li>• 8 Cm Circular Fenestration</li> </ul>	80x80





## OPHTHALMIC DRAPE

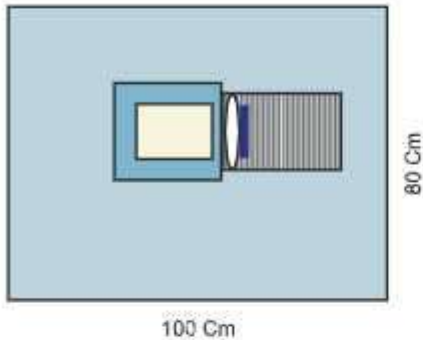

Product Code #	Description	Size(cm)
30281-0000	Ophthalmic Drape <ul style="list-style-type: none"> <li>• Absorbent Laminated reinforcement</li> <li>• 9x4 Cm Fenestration</li> <li>• Incise</li> <li>• Fluid Collection Pouch</li> <li>• Light weight fabric</li> </ul>	100x80

## OPHTHALMIC DRAPE

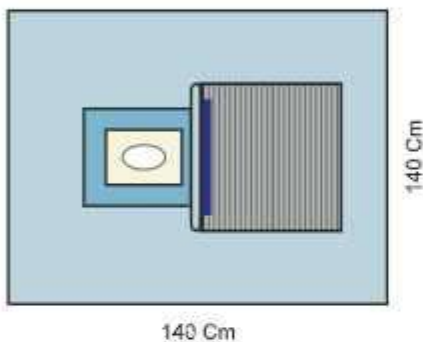

Product Code #	Description	Size(cm)
30283-0000	Ophthalmic Drape <ul style="list-style-type: none"> <li>• 5x7 Cm Oval Fenestration</li> <li>• Light Weight Fabric</li> <li>• Incise</li> <li>• Absorbent Laminated Reinforcement</li> <li>• Fluid Collection Pouch</li> </ul>	140x140

## HEAD DRAPE WITH TURBAN

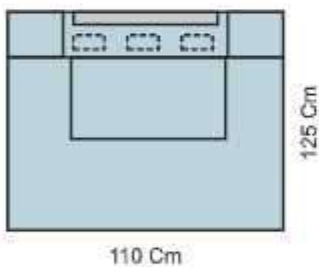

Product Code #	Description	Size(cm)
32101-0000	Head Drape with Turban <ul style="list-style-type: none"> <li>• Adhesive</li> <li>• Turban 50x80 Cm</li> </ul>	125x110

## HEAD DRAPE WITH ABSORBENT REINFORCEMENT

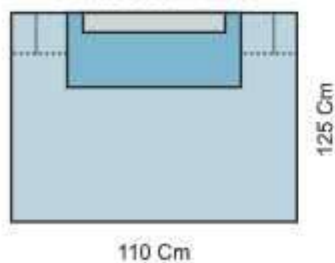

Product Code #	Description	Size(cm)
32102-0000	Head Drape with Absorbent Reinforcement <ul style="list-style-type: none"> <li>• Adhesive</li> <li>• Absorbent laminated reinforcement</li> </ul>	110x125





ENT SPLIT DRAPE

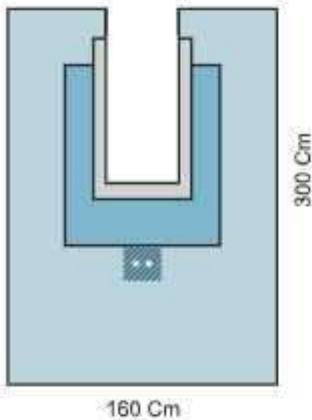

Product Code #	Description	Size(cm)
30214-0000	ENT Split Drape <ul style="list-style-type: none"> <li>• Adhesive</li> <li>• 7x57 Cm Split</li> <li>• Absorbent Laminated Reinforcement</li> <li>• Tube holder</li> </ul>	300x160

OPHTHALMIC DRAPE

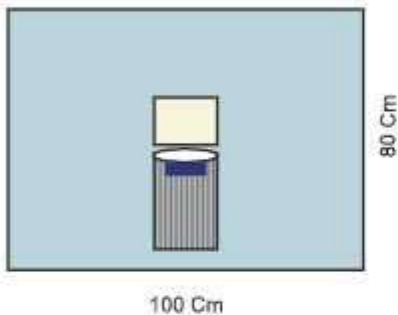

Product Code #	Description	Size(cm)
30282-0000	Ophthalmic Drape <ul style="list-style-type: none"> <li>• Incise 9x6.5 Cm Fenestration</li> <li>• Fluid Collection Pouch</li> <li>• Light Weight Fabric</li> </ul>	80x100

OPHTHALMIC DRAPE

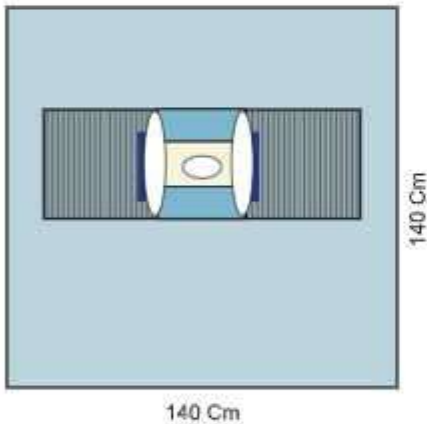

Product Code #	Description	Size(cm)
30284-0000	Ophthalmic Drape <ul style="list-style-type: none"> <li>• Light Weight Fabric</li> <li>• 5x7 Cm Oval Fenestration</li> <li>• Dual Fluid Collection Pouch</li> <li>• Absorbent Laminated Reinforcement</li> <li>• Incise</li> </ul>	140x140

EYE DRAPE

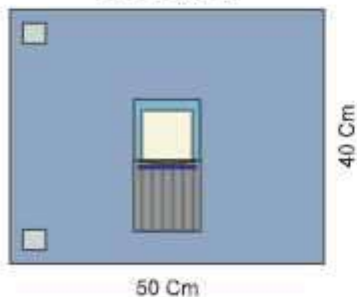

Product Code #	Description	Size(cm)
30211-0000	Eye Drape <ul style="list-style-type: none"> <li>• MII Poly Plastic Blue</li> <li>• Absorbent Laminated reinforcement</li> <li>• Adhesive</li> <li>• Incise</li> <li>• Fluid Collection Pouch</li> <li>• 9x4 fenestration</li> </ul>	40x50



## Dental Pack : Product Code - #66804 - 0000

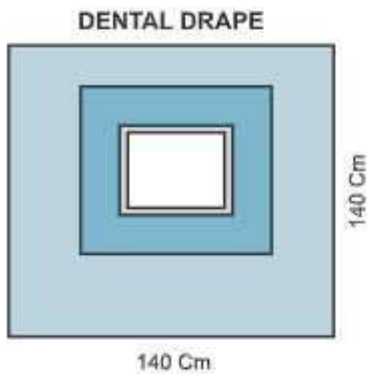

Item Code	Qty.	Contents	Size(cm)
085-160-100S	1 PC	Back Table Cover Reinforced	160x100
CR 143027-024	2 PCS	Surgical Gown	L
CR 143029-000	2 PCS	Hand Towel	30x30
CR 143041-012	6 PCS	Mopping Pad	30x30
40101-0000	1 PC	Dental Drape	
		<ul style="list-style-type: none"> <li>• Adhesive</li> <li>• Absorbent Laminated Reinforcement</li> <li>• 12x12 Square Fenestration</li> </ul>	
085-160-125S	1 PC	Trolley Sheet	160x125
CP 141066-00	1 PC	Carry Bag	

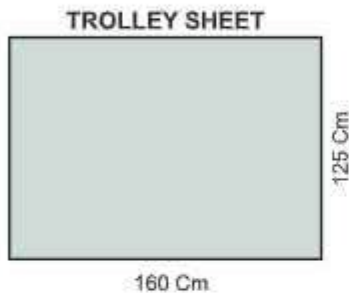

**Thyroid Pack : Product Code - #66602-0000**

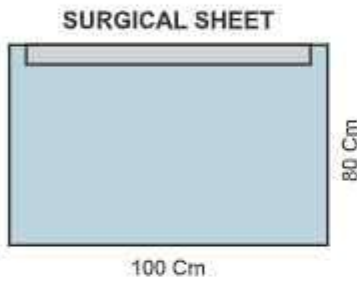
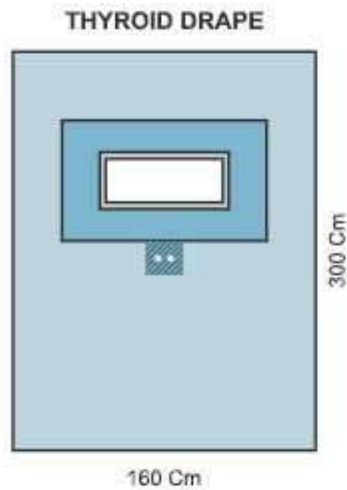

Item Code	Qty.	Contents	Size(cm)
085-160-100S	1 PC	Back Table Cover Reinforced	160x100
CR 143027-030	2 PCS	Surgical Gown Reinforced	L
CR 143029-000	2 PCS	Hand Towel	30x30
CR 143041-012	6 PCS	Mopping Pad	30x30
043-080-100A	2 PCS	Surgical Drape with Adhesive	100x80
		• Adhesive	
085-160-125S	1 PC	Trolley Sheet	160x125
30312-0000	1 PC	Thyroid Drape	160x300
		• Adhesive	
		• Absorbent Laminated Reinforcement	
		• 8x20 Cm Fenestration	
		• Tube Holder	
CP 141066	1 PC	Carry Bag	



## Eye Pack I : Product Code - #66601-0001

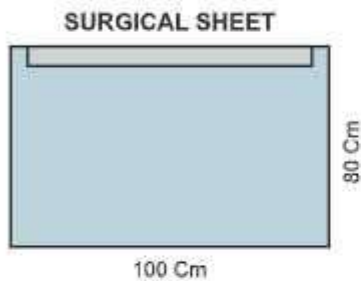
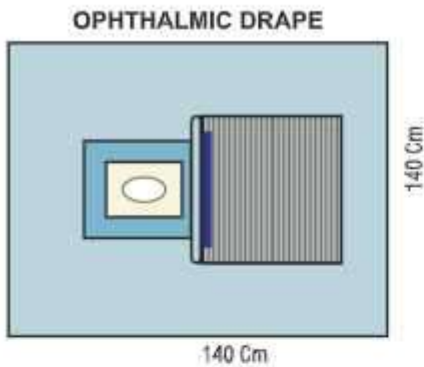

Item Code	Qty.	Contents	Size(cm)
085-160-100S	1 PC	Back Table Cover Reinforced	160x100
CR 143027-024	2 PCS	Surgical Gown	
CR 143029-000	2 PCS	Hand Towel	30x30
CC 149042-000	1 PC	Eye Pad	
CR 143024-002	10 PCS	Gauze Swab X-Ray Detectable	10x10
30283-0000	1 PC	Ophthalmic Drape with Fluid Collection Pouch	140x140
		<ul style="list-style-type: none"> <li>• 5x7 Cm Oval Fenestration</li> <li>• Light Weight Fabric</li> <li>• Incise</li> <li>• Absorbent Laminated Reinforcement</li> <li>• Fluid Collection Pouch</li> </ul>	
030-160-125S	1 PC	Trolley Sheet	160x125
043-080-100A	2 PCS	Surgical Sheet	100x80
CP 141066-000	1 PC	*Adhesive Carry Bag	

## Eye Pack II : Product Code - #66601-0002

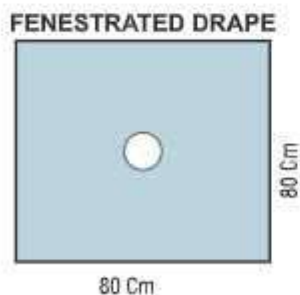
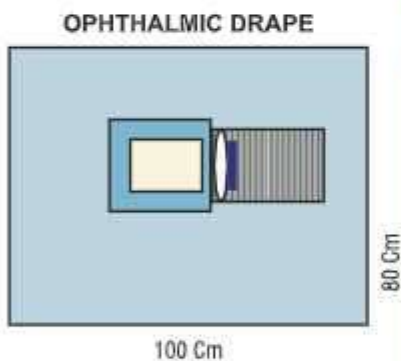

Item Code	Qty.	Contents	Size(cm)
085-160-125S	1 PC	Back Table Cover Reinforced	160x125
043-160-100S	1 PC	Surgical Sheet	160x100
30281-0000	1 PC	Eye Drape	100x80
		<ul style="list-style-type: none"> <li>• Incise</li> <li>• Fluid Collection Pouch</li> <li>• 9x4 Cm Fenestration</li> </ul>	
043-080-080S	1 PC	Fenestrated Drape	80x80
		<ul style="list-style-type: none"> <li>• 8 Cm Circular Fenestration</li> </ul>	
043-080-100A	2 PCS	Surgical Sheet with Adhesive	100x80
		<ul style="list-style-type: none"> <li>• Adhesive</li> </ul>	
030-160-125S	1 PC	Trolley Sheet	160x125
CP 141066-000	1 PC	Carry Bag	





## Eye Pack III : Product Code - #66601-0003

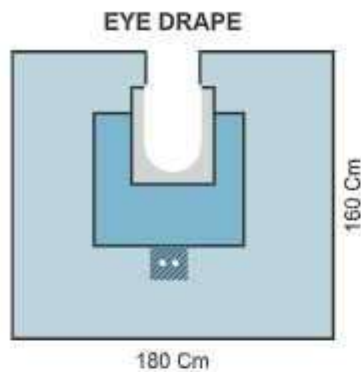

**HEAD DRAPE WITH ABSORBENT REINFORCEMENT**

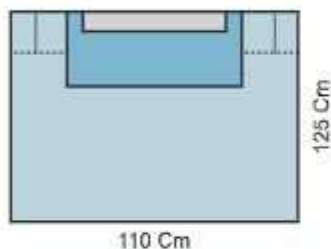

Item Code	Qty.	Contents	Size(cm)
085-160-100S	1 PC	Back Table Cover Reinforced	160x100
CR 143027-024	1 PC	Surgical Gown	L
CR 143029-000	2 PCS	Hand Towel	30x30
CR 143029-000	4 PCS	Hand Towel	30x30
CC 149042-000	1 PC	Eye Pad	
CR 143024-002	10 PCS	Gauze Swab X-Ray Detectable	10x10
32102-0000	1 PC	Head Drape	110x95
		• Adhesive	
		• Absorbent Laminated Reinforcement	
30213-0000	1 PC	Eye Drape	160x180
		• Adhesive	
		• Absorbent Laminated Reinforcement	
		• Tube Holder	
030-160-125S	1 PC	Trolley Sheet	160x125
CP 141066-000	1 PC	Carry Bag	

## ENT Pack I : Product Code - #66601-0000

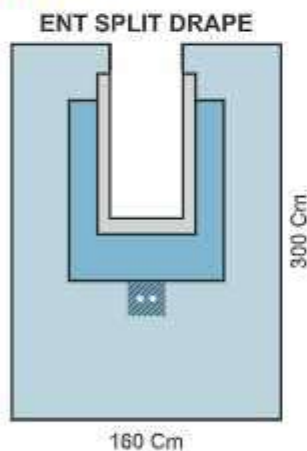

**HEAD DRAPE WITH TURBAN**

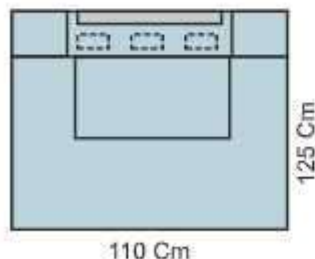

Item Code	Qty.	Contents	Size(cm)
085-160-100S	1 PC	Back Table Cover Reinforced	160x100
CR 143027-024	1 PC	Surgical Gown	L
CR 143029-000	1 PC	Hand Towel	30x30
CR 143039-000	1 PC	Mayo Stand Cover Reinforced	80x80
043-060-040A	2 PCS	Utility Drape	60x40
		• Adhesive	
CC 142002-001	1 PC	Diathermy Bag	30x35
		• Adhesive	
CR 143029-000	2 PCS	Hand Towel	30x30
32101-0000	1 PC	Head Drape with Turban	125x110
		• Adhesive	
		• Turban 50x80 Cm	
30214-0000	1 PC	EENT Drape	160x130
		• Adhesive	
		• Absorbent Laminated Reinforcement	
		• Tube Holder	
		• 7x57 Cm Split	
030-160-125S	1 PC	Trolley Sheet	160x125
CP 141066-000	1 PC	Carry Bag	





# Gynecology & Obstetrics

- **Single Drapes**
- **Laparoscopy Packs**
- **Caesarean Packs**
- **Delivery Packs**
- **Lithotomy Packs**

**LAPAROSCOPY DRAPE WITH ATTACHED LEGGING**

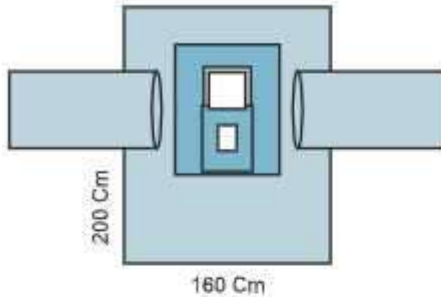

Product Code #	Description	Size(cm)
43101-000	Laparoscopy Drape with Attached Legging <ul style="list-style-type: none"> <li>• 15x20 cm Perineal Fenestration</li> <li>• Absorbent Laminated Reinforcement</li> <li>• Adhesive</li> <li>• Leggings</li> <li>• 30x30 Abdominal Fenestration</li> </ul>	200x160

**LAPAROSCOPY T" DRAPE**

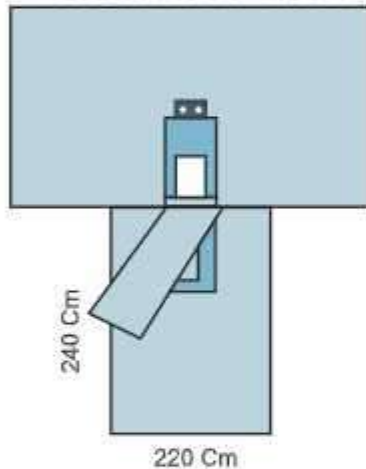

Product Code #	Description	Size(cm)
43102-000	Laparoscopy T" Drape <ul style="list-style-type: none"> <li>• 15x7 cm Perineal Fenestration with Flap</li> <li>• 15x20 Abdominal Fenestration</li> <li>• Absorbent Laminated Reinforcement</li> <li>• Tube Holder</li> <li>• Adhesive</li> </ul>	240x220

**ABDOMINAL DRAPE**

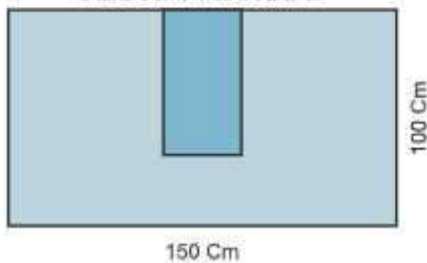

Product Code #	Description	Size(cm)
40001-000	Abdominal Drape <ul style="list-style-type: none"> <li>• Adhesive</li> <li>• Absorbent Laminated Reinforcement</li> </ul>	150x100





## LEGGINGS

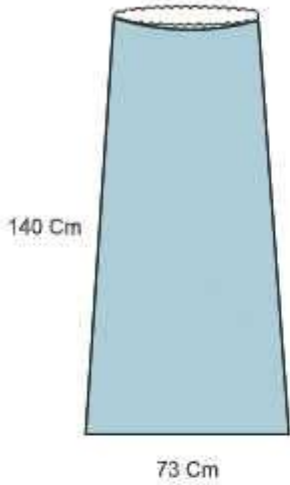

Product Code #	Description	Size(cm)
CC 142005-002	Leggings Plastic Blue • Latex free elastic closure	140x73

## CONE SHAPE LEGGINGS

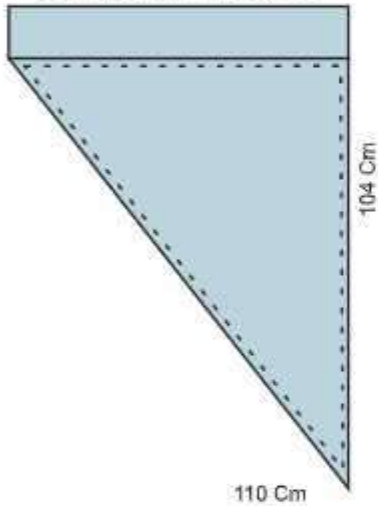

Product Code #	Description	Size(cm)
CC 142005-004	Cone Shape Leggings	104x110

## CONE SHAPE FOOT COVER

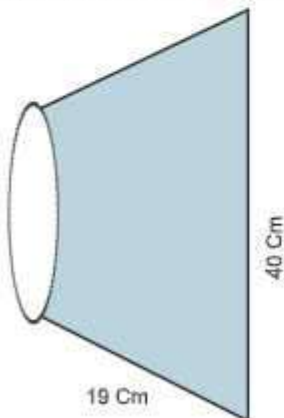

Product Code #	Description	Size(cm)
CC 142005-005	Cone Shape Foot Cover • Latex Free Elastic Closure	19x140





## LEGGINGS BLUE PLASTIC

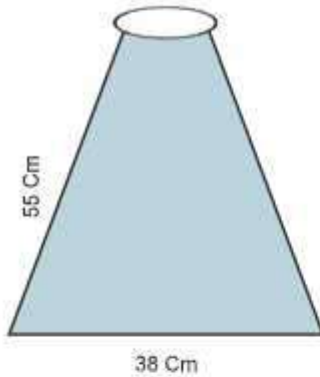

Product Code #	Description	Size(cm)
CC 142005-003	Leggings Blue Plastic • Latex Free Elastic Closure	55x38

## MATERNITY MAT WITH POUCH

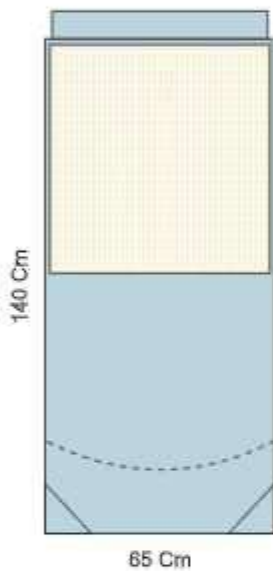

Product Code #	Description	Size(cm)
CR 143038-007	Maternity Mat with Pouch • Under Pad • Laminated Sheet	140x65

## MATERNITY MAT WITH FLUID COLLECTION POUCH

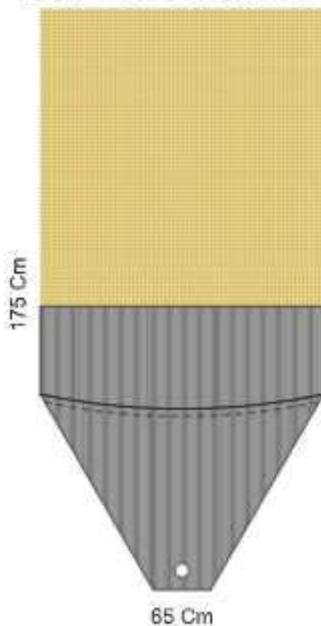

Product Code #	Description	Size(cm)
CR 143038-004	Maternity Mat with Fluid Collection Pouch • Under Pad • Fluid Collection Pouch	175x65



## LEGGINGS

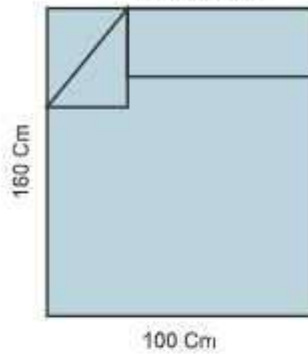

Product Code #	Description	Size(cm)
CC 142005-000	Leggings	160x100

## UNDER BUTTOCKS DRAPE WITH FLUID COLLECTION POUCH

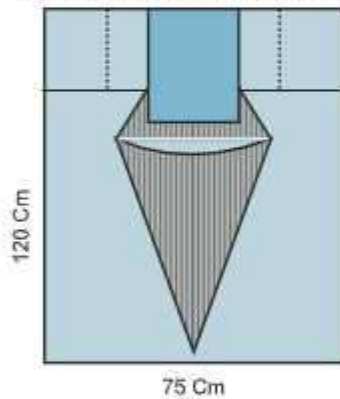

Product Code #	Description	Size(cm)
CR 143038-005	Under Buttocks Drape with Fluid Collection Pouch <ul style="list-style-type: none"> <li>• Adhesive</li> <li>• Absorbent Laminated Reinforcement</li> <li>• Fluid Collection Pouch</li> </ul>	75x120

## UNDER BUTTOCKS DRAPE WITH ABSORBENT PAD

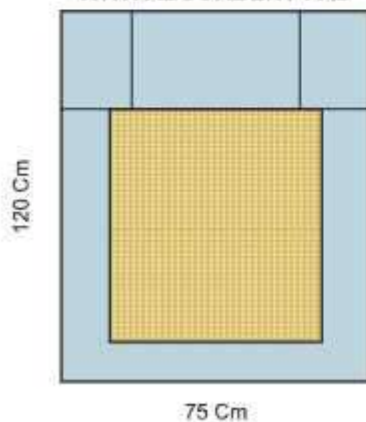

Product Code #	Description	Size(cm)
CR 143038-006	Under Buttocks Drape with Absorbent Pad <ul style="list-style-type: none"> <li>• Absorbent Pad</li> </ul>	75x120



## LITHOTOMY T™ SHEET

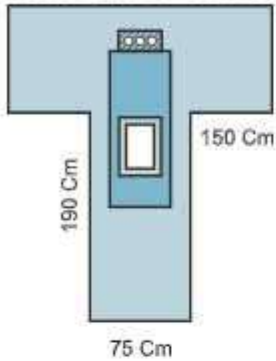

Product Code #	Description	Size(cm)
30226-0000	Lithotomy T™ Sheet <ul style="list-style-type: none"> <li>• Adhesive</li> <li>• Absorbent Laminated Reinforcement</li> <li>• Tube Holder</li> <li>• 7x15 Cm Perineal Fenestration</li> </ul>	190x150

## C-SECTION DRAPE

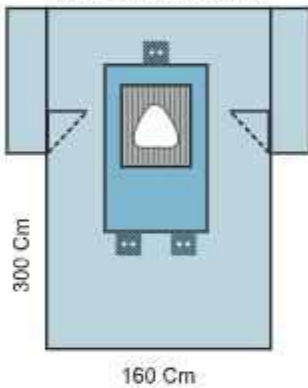

Product Code #	Description	Size(cm)
30162-0000	C-Section Drape <ul style="list-style-type: none"> <li>• Adhesive</li> <li>• 20x20 Cm Tear Drop Fenestration</li> <li>• Absorbent Laminated Reinforcement</li> <li>• Tube Holder</li> <li>• Arm Board Covers</li> </ul>	300x160

## CAESAREAN DRAPE WITH FLUID COLLECTION POUCH

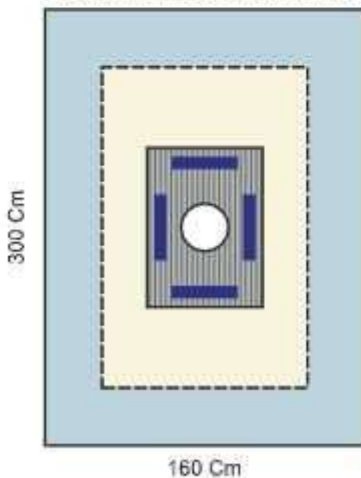

Product Code #	Description	Size(cm)
30161-0000	Caesarean Drape with Fluid Collection Pouch <ul style="list-style-type: none"> <li>• Hygiene Sheet</li> <li>• Fluid Collection Pouch</li> <li>• Incise</li> <li>• 30 Cm Circular Fenestration</li> </ul>	300x160



**LARGE SHEET**

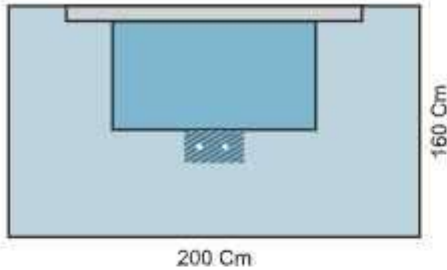

Product Code #	Description	Size(cm)
41013-0000	Large Sheet <ul style="list-style-type: none"> <li>• Absorbent Laminated Reinforcement</li> <li>• Adhesive</li> <li>• Tube Holder</li> </ul>	160x200

**MEDIUM SHEET**

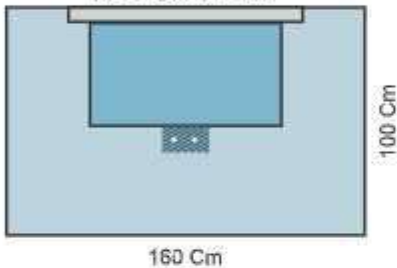

Product Code #	Description	Size(cm)
41014-0000	Medium Sheet <ul style="list-style-type: none"> <li>• Absorbent Laminated Reinforcement</li> <li>• Adhesive</li> <li>• Tube Holder</li> </ul>	160x100

**SMALL SHEET**

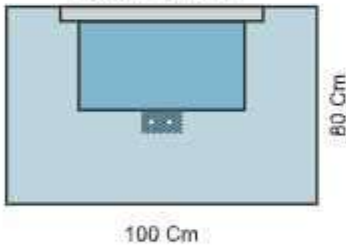

Product Code #	Description	Size(cm)
41015-0000	Small Sheet <ul style="list-style-type: none"> <li>• Absorbent Laminated Reinforcement</li> <li>• Adhesive</li> <li>• Tube Holder</li> </ul>	100x80

**EXTRA SMALL SHEET**

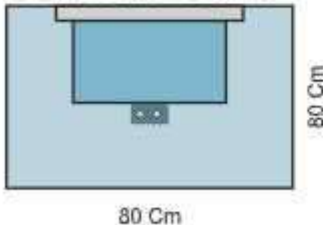

Product Code #	Description	Size(cm)
41016-0000	Extra Small Sheet <ul style="list-style-type: none"> <li>• Absorbent Laminated Reinforcement</li> <li>• Adhesive</li> </ul>	80x80





**SURGICAL SHEET MEDIUM**

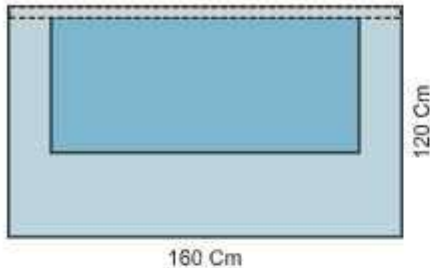

Product Code #	Description	Size(cm)
40015-0000	Surgical Sheet Medium <ul style="list-style-type: none"> <li>• Adhesive</li> <li>• Absorbent Laminated Reinforcement</li> </ul>	160x120

**SURGICAL SHEET**

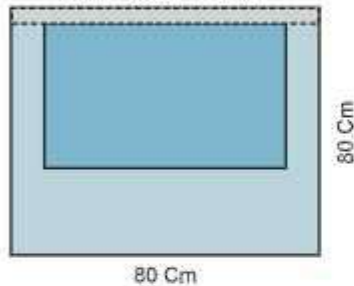

Product Code #	Description	Size(cm)
40017-0000	Surgical Sheet <ul style="list-style-type: none"> <li>• Adhesive</li> <li>• Absorbent Laminated Reinforcement</li> </ul>	80x80

**SURGICAL SHEET SMALL**

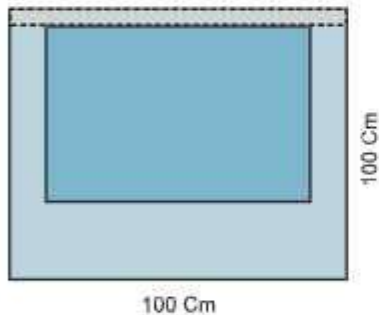

Product Code #	Description	Size(cm)
40016-0000	Surgical Sheet Small <ul style="list-style-type: none"> <li>• Adhesive</li> <li>• Absorbent Laminated Reinforcement</li> </ul>	100x100

**SMALL FENESTRATED SHEET**

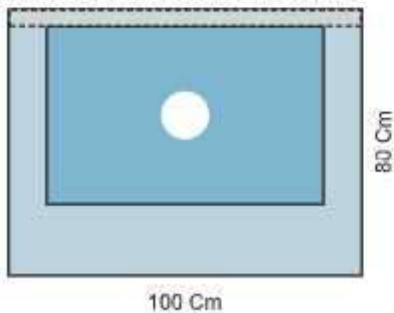

Product Code #	Description	Size(cm)
40011-0000	Small Fenestrated Sheet <ul style="list-style-type: none"> <li>• 8 Cm Circular Fenestration</li> <li>• Absorbent Laminated Reinforcement</li> </ul>	100x80



## Laparoscopy Pack I : Product Code - #66481-0001

### LAPAROSCOPY DRAPE WITH ATTACHED LEGGING

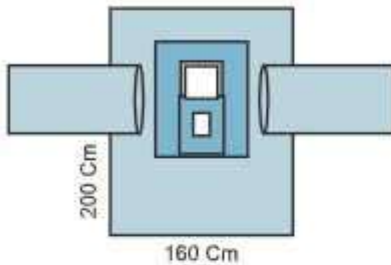

### CAMERA COVER



Item Code	Qty.	Contents	Size(cm)
318-080-100S	1 PC	Back Table Cover Reinforced	100x80
CR 143027-024	3 PCS	Surgical Gown	L
CR 143029-000	3 PCS	Hand Towel	30x30
43101-0000	1 PC	Laparoscopy Drape with Attached Leggings <ul style="list-style-type: none"> <li>• 150x20 Cm Perineal Fenestration</li> <li>• 30x30 Cm Abdominal Fenestration</li> <li>• Absorbent Laminated Reinforcement</li> <li>• Adhesive</li> <li>• Leggings</li> </ul>	200x160
CR 143010-002	1 Pc	Camera Cover Plastic	20x200
CP 141066-000	1 Pc	Carry Bag	

## Laparoscopy Pack II: Product Code - #66481-0002

### LAPAROSCOPY T" DRAPE

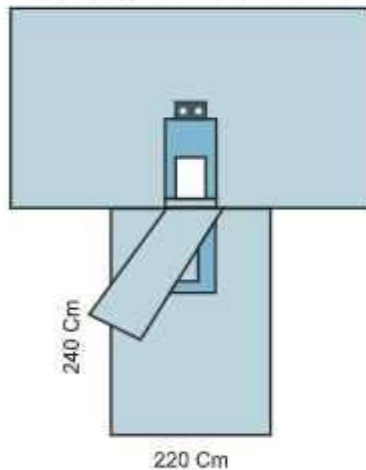

### LEGGINGS

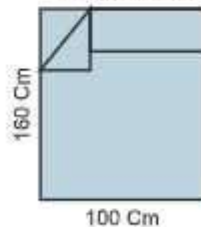

Item Code	Qty.	Contents	Size(cm)
085-160-100S	1 PC	Back Table Cover Reinforced	160x100
CR 143027-024	3 PCS	Surgical Gown	L
CR 143029-000	3 PCS	Hand Towel	30x30
CR 143038-006	1 PC	Under Buttocks Drape with Absorbent Pad <ul style="list-style-type: none"> <li>• Absorbent Pad</li> </ul>	75x120
CR 143029-000	1 PC	Hand Towel	30x30
043-060-040A	2 PCS	Utility Drape <ul style="list-style-type: none"> <li>• Adhesive</li> </ul>	60x40
CC 142005-000	2 PCS	Leggings	160x100
43102-0000	1 PC	Laparoscopy T" Sheet <ul style="list-style-type: none"> <li>• 15x7 Cm Perineal Fenestration with Flap</li> <li>• 15x20 Cm Abdominal Fenestration</li> <li>• Absorbent Laminated Reinforcement</li> <li>• Tube Holder</li> <li>• Adhesive</li> </ul>	240x220
CP 141066-000	1 PC	Carry Bag	



## Caesarian Pack I : Product Code - #66451-0001

CAESAREAN DRAPE WITH FLUID COLLECTION POUCH

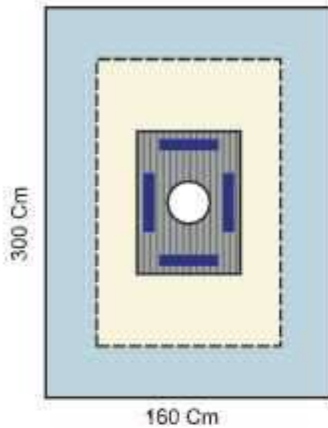

DAITHERMY BAG

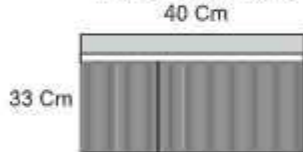

Item Code	Qty.	Contents	Size(cm)
085-160-100S	1 PC	Back Table Cover Reinforced	160x100
CR 143027-024	1 PC	Surgical Gown	L
CR 143029-000	1 PC	Hand Towel	30x30
CR 143027-030	2 PCS	Surgical Gown Reinforced	L
CR 143029-000	2 PCS	Hand Towel	30x30
CR 143041-006	10 PCS	Gauze Swabs with X-ray Detectable	45x45
CR 143123-000	1 Pc	Connecting Tubing 10" Feet	
CR 143120-000	1 PC	Yenkuear Tip	
CR 143120-000	1 PC	Bulb Syringe	
CR 143104-000	2 PCS	Cord Clamp Lock	
CC 142002-000	1 PC	Diathermy Bag	30x35
		• Adhesive	
CR 143039-000	1 PC	Mayo Stand Cover	80x80
30161-0000	1 PC	Caesarian Drape with Fluid Collection Pouch	
		• Hygiene Sheet	
		• Fluid Collection Pouch	
		• Incise	
		• 30 Cm Circular Fenestration	
CR 143033-002	1 PC	ID Band	Infant
CR 141066-000	1 PC	Carry Bag	

## Caesarian Pack II : Product Code - #66451-0002

CAESAREAN DRAPE WITH FLUID COLLECTION POUCH

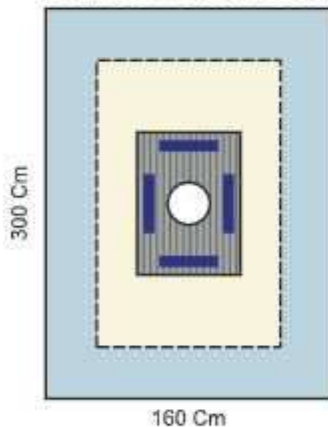

Item Code	Qty.	Contents	Size(cm)
085-160-100S	1 PC	Back Table Cover Reinforced	160x100
CR 143027-024	3 PCS	Surgical Gown	L
CR 143029-000	3 PCS	Hand Towel	30x30
CR 143041-012	6 PCS	Mopping Pad	30x30
30161-0000	1 PC	Caesarian Drape with Fluid Collection Pouch	
		• Hygiene Sheet	
		• Fluid Collection Pouch	
		• Incise	
		• 30 Cm Circular Fenestration	
CR 143039-000	1 PC	Mayo Stand Cover	80x80
CP 141066-000	1 PC	Carry Bag	





## Caesarian Pack III : Product Code - #66451-0003

### FENESTRATED ABSORBENT SHEET

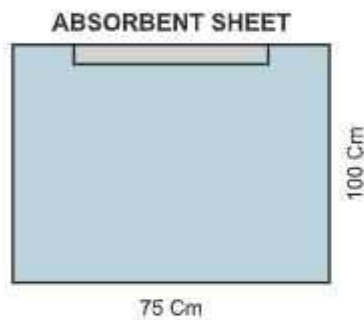
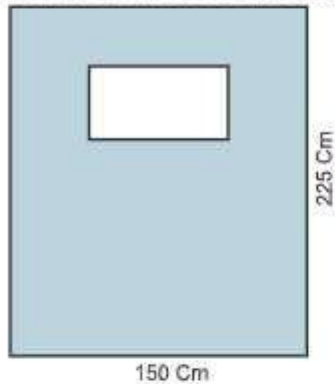

Item Code	Qty.	Contents	Size(cm)
085-160-100S	1 PC	Back Table Cover Reinforced	160x100
CR 143027-024	3 PCS	Surgical Gown	L
CR 143029-000	3 PCS	Hand Towel	30x30
065-150-100S	2 PCS	Absorbent Sheet	150x100
065-100-075A	2 PCS	Absorbent Sheet	100x75
065-150-225S	1 Pc	Absorbent Fenestrated Sheet • Adhesive	150x225
CR 143243-002	1 PC	ISO Seal Drape Tape Strips	5x20
CR 143041-012	6 PCS	Mopping Pad	30x30
CR 143084-000	1 PC	Under Pad	60x60
CR 143039-000	1 PC	Mayo Stand Cover	80x80
043-160-100S	1 PC	Surgical Sheet	160x100
CR 143005-001	1 PC	Apron	L
043-080-080S	1 PC	Surgical Sheet	80x80
CR 143033-002	1 PC	ID Band Infant Pink	
CR 143014-000	1 PC	Cord Clamp Lock	
CP 141066-000	1 PC	Carry Bag	

## Caesarian Pack IV : Product Code - #66451-0004

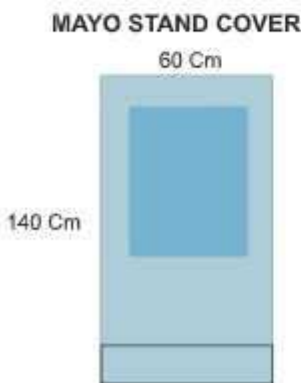
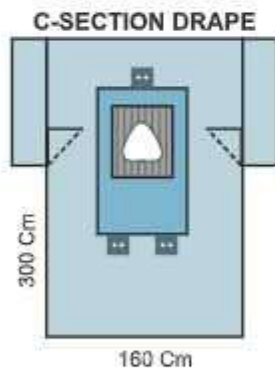

Item Code	Qty.	Contents	Size(cm)
085-160-100S	1 PC	Back Table Cover Reinforced	160x100
CR 143027-030	3 PCS	Surgical Gown Reinforced	L
CR 143029-000	3 PCS	Hand Towel	30x30
CR 143030-004	1 PC	Mayo Stand Cover	60x140
CR 143041-012	6 PCS	Mopping Pad	30x30
CR 143041-006	2 PC	Gauze Swap X-ray Detectable	45x45
30162-0000	1 PC	C-Section Drape *Absorbent Laminated Reinforcement *Adhesive *20x20 Cm Tear Drop Fenestration *Tube Holder *Arm Board Covers	
CR 143121-000	1 PC	Bulb Syringe	
CR 143014-000	1 PC	Cord Clamp Lock	
065-075-075S	1 PC	Absorbent Sheet	75x75
CR 143033-003	1 PC	ID Band Infant Pink	
CR 143005-001	1 PC	Apron	Large
CP 141066-000	1 PC	Carry Bag	





## Delivery Pack I : Product Code - #66551-0001

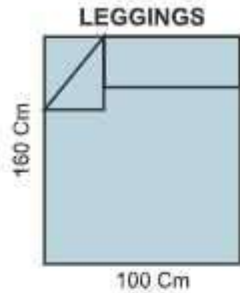

**UNDER BUTTOCKS DRAPE WITH FLUID COLLECTION POUCH**

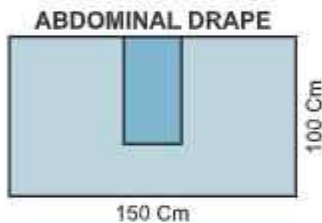
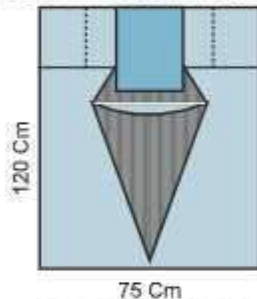

Item Code	Qty.	Contents	Size(cm)
085-160-100S	1 PC	Back Table Cover Reinforced	160x100
043-110-200S	1 PC	Set Up Cover	110x200
CR 143027-024	1 PC	Surgical Gown	L
CR 143029-000	2 PCS	Hand Towels	30x30
065-075-075S	1 PC	Absorbent Sheet	75x75
CR 143038-005	1 PC	Under Buttocks Drape with Fluid Collection Pouch	120x75
CC1 42005-000	2 PCS	Leggings with 15 Cm Cuffs	160x100
40001-0000	1 PC	Abdominal Drape	150x150
CR 143038-003	1 PC	Maternity Pad	
CR 143014-000	1 PC	Cord Clamp Lock	
CR 141127-000	1 PC	Vaginal Packing Sponge	
CR 143121-000	1 PC	Bulb Syringe	
CR 143024-002	10 PCS	Gauze Swab X-Ray Detectable	10x10
CP 141081-004	1 PC	Placenta Basin	
CP 141066-000	1 PC	Carry Bag	

## Delivery Pack II : Product Code - #66551-0002

**MATERNITY MAT WITH POUCH**

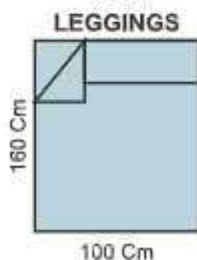
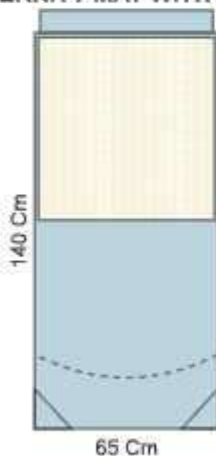

Item Code	Qty.	Contents	Size(cm)
085-160-100S	1 PC	Back Table Cover Reinforced	160x100
CR 143005-000	2 PC	Apron	XL
CC 142023-000	1 PC	Maternity Mat with Pouch	
		• Under Pad	
		• Laminated Fabric	
CC 142005-000	2 PCS	Leggings	160x100
065-100-075S	1 PC	Absorbent Sheet	100x75
CR 143041-012	2 PCS	Mopping Pad	30x30
CR 143029-000	4 PCS	Hand Towels	30x30
065-075-075S	1 PC	Absorbent Baby Sheet	75x75
CR 143033-003	1 PC	ID Band Infant Pink Plain	
CR 143014-000	1 PC	Cord Clamp Lock	
CP 141066-000	1 PC	Carry Bag	



## Delivery Pack III : Product Code - #66551-0003

**MATERNITY MAT WITH FLUID COLLECTION POUCH**

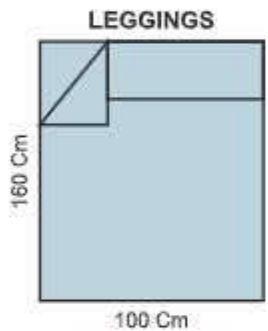
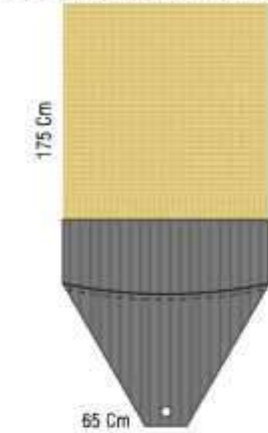

Item Code	Qty.	Contents	Size(cm)
085-160-100S	1 PC	Back Table Cover Reinforced	160x100
CR 143027-024	2 PCS	Surgical Gowns	L
CR 143029-000	2 PCS	Hand Towels	
CR 143038-003	1 PC	Maternity Pad	
CC 142005-000	2 PCS	Leggings	160x100
CR 143038-004	1 PC	Maternity Mat with Fluid Collection Pouch	120x75
		• Maternity Absorbent Pad	
		• Fluid Collection Pouch	
		• Adhesive	
065-075-075S	2 PCS	Absorbent Sheet	75x75
CC 142013-000	1 PC	Absorbent Mat	30x30
CR 143005-000	2 PCS	Apron	XL
CR 143033-003	1 PC	ID Band Infant Pink Plain	
CR 143014-000	1 PC	Cord Clamp Lock	
CR 143084-000	1 PC	Under Pad	60x60
CR 143041-012	4 PCS	Mopping Pad	30x30
CP 141066-000	1 PC	Carry Bag	

## Lithotomy Pack I : Product Code - #66563-0001

**LITHOTOMY T<sup>m</sup> SHEET**

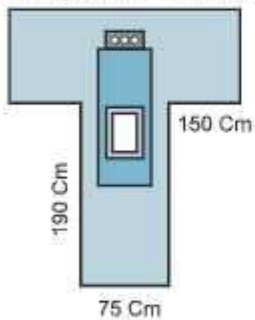

**UNDER BUTTOCKS DRAPE WITH ABSORBENT PAD**

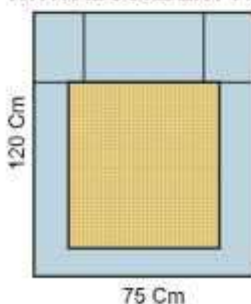

Item Code	Qty.	Contents	Size(cm)
085-160-100S	1 PC	Back Table Cover Reinforced	160x100
CR 143027-024	2 PCS	Surgical Gowns	L
CR 143029-000	2 PCS	Hand Towels	30x30
043-060-040A	2 PCS	Utility Drape	60x40
		• Adhesive	
CC 142005-000	2 PCS	Leggings	160x100
CR 143029-000	1 PC	Hand Towel	30x30
30226-0000	1PC	Lithotomy T <sup>m</sup> Sheet	190x150
		• 7x15 Cm Perineal Fenestration	
		• Adhesive	
		• Absorbent Laminated Reinforcement	
		• Tube Holder	
CR 143038-006	1 PC	Under Buttocks Drape with Absorbent Pad	
		• Absorbent Pad	
CP 141066-000	1 PC	Carry Bag	



## Lithotomy Pack II : Product Code - #66563-0002

**UNDER BUTTOCKS DRAPE WITH ABSORBENT PAD**

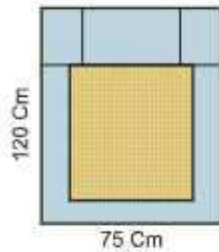

**SURGICAL SHEET**

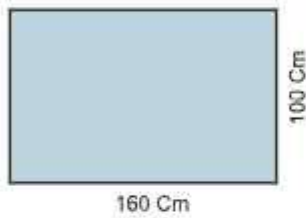

**LEGGINGS**

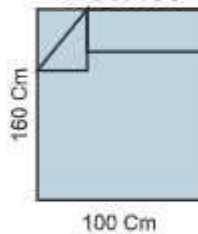

**UTILITY DRAPE**

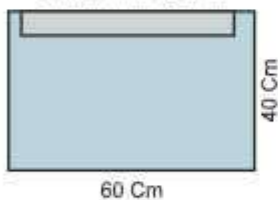

Item Code	Qty.	Contents	Size(cm)
085-160-100S	1 PC	Back Table Cover Reinforced	160x100
CR 143027-024	1 PC	Surgical Gowns	L
CR 143029 - 000	2 PCS	Hand Towels	30x30
043-060-040A	2 PCS	Utility Drape	60x40
CR 143038-005	1 PC	Under Buttocks Drape with Absorbent Pad	
		• Absorbent Pad	
CC 142005-000	2 PCS	Leggings	160x100
043-160-1005	1 PC	Surgical Sheet	160x100
CP 141066-000	1 PC	Carry Bag	







# Urology Packs & Drapes

- **Single Drapes**
- **PCNL Packs**
- **Cystoscopy Packs**
- **TURP Packs**



## CYSTOSCOPY T<sup>m</sup> DRAPE

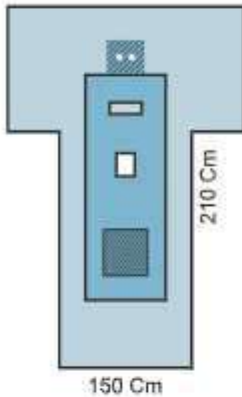

Product Code #	Description	Size(cm)
30354-0000	Cystoscopy T <sup>m</sup> Drape <ul style="list-style-type: none"> <li>• 15x7 Cm Perineal Fenestration</li> <li>• 22x22 Cm Screen</li> <li>• Absorbent Laminated Reinforcement</li> <li>• Tube Holder</li> <li>• Adhesive</li> </ul>	150x210

## T.U.R.P. DRAPE WITH LEGGINGS

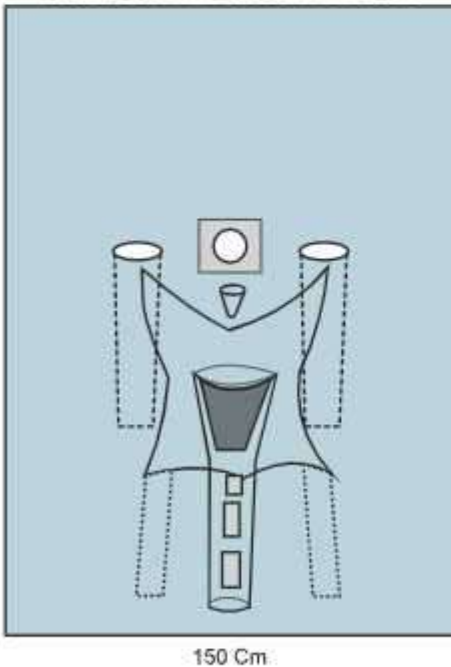

Product Code #	Description	Size(cm)
30351-0000	T.U.R.P. Drape with Leggings <ul style="list-style-type: none"> <li>• Adhesive</li> <li>• Incise</li> <li>• Funnel</li> <li>• Finger Cot</li> <li>• Screen 10x23 Cm</li> <li>• Leggings</li> <li>• 8Cm Circular Fenestration</li> </ul>	160x150



PCNL DRAPE

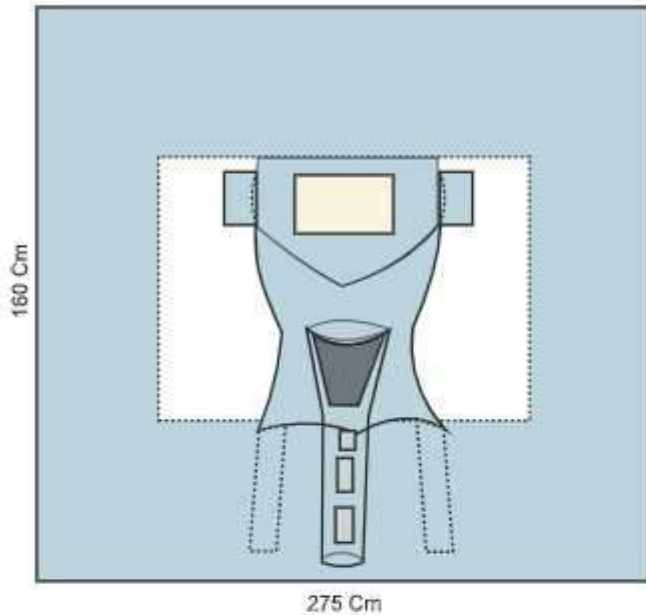

Product Code #	Description	Size(cm)
30051-0000	PCNL Drape <ul style="list-style-type: none"> <li>• Hygiene Sheet</li> <li>• Fluid collection pouch</li> <li>• Adhesive</li> <li>• Incise</li> </ul>	160x275

## PCNL Pack : Product Code - #66771-0000

PCNL DRAPE

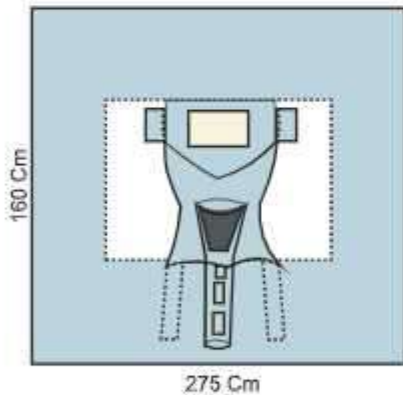

Item Code	Qty.	Contents	Size(cm)
085-160-100S	1 PC	Back Table Cover Reinforced	160x100
CR 143027-024	3 PCS	Surgical Gown	L
CR 143029-000	3 PCS	Hand Towels	30x30
30051-0000	1 PC	PCNL Drape <ul style="list-style-type: none"> <li>• Adhesive</li> <li>• Incise</li> <li>• Funnel</li> <li>• Screen 10x23 Cm</li> <li>• 26x21 Cm Fenestration</li> <li>• Hygiene</li> </ul>	160x280
CR 143005-001	3 PCS	Apron	L
CP 141066-000	1 PC	Carry Bag	

APRON

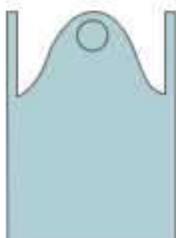

## Cystoscopy Pack : Product Code - #66703-0000

CYSTOSCOPY T<sup>®</sup> DRAPE

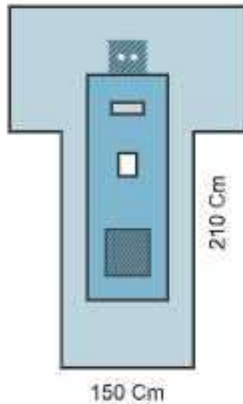

LEGGINGS

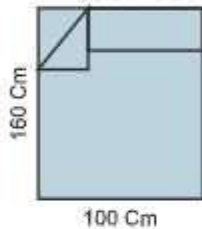

Item Code	Qty.	Contents	Size(cm)
085-160-100S	1 PC	Back Table Cover Reinforced	160x100
CR 143027-030	1 PC	Surgical Gown Reinforced	L
CR 143029-000	2 PCS	Hand Towels	30x30
CR 143024-002	10 PCS	Gauze Swab X-Ray Detectable	10x10
CC 142005-000	2 PCS	Leggings	160x100
30354-0000	1 PC	Cystoscopy T <sup>®</sup> Drape <ul style="list-style-type: none"> <li>Absorbent Laminated Reinforcement</li> <li>Adhesive</li> <li>15x7 Cm Perineal Fenestration</li> <li>22x22 Cm Screen</li> <li>Tube Holder</li> </ul>	
CP 141066-000	1 PC	Carry Bag	

## TURP Pack : Product Code - #66705-0000

T.U.R.P. DRAPE WITH LEGGINGS

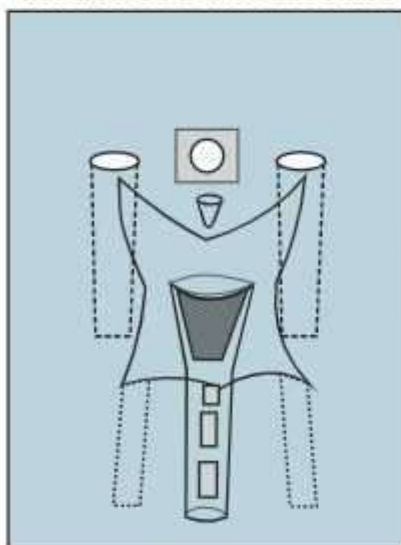

Item Code	Qty.	Contents	Size(cm)
085-160-100S	1 PC	Back Table Cover Reinforced	160x100
CR 143029-000	2 PCS	Hand Towels	30x30
CR 143027-024	1 PC	Surgical Gown	L
30351-0000	1 PC	TURP Drape with Leggings <ul style="list-style-type: none"> <li>Adhesive</li> <li>Incise</li> <li>Funnel</li> <li>Finger Cot</li> <li>Screen 10x23 Cm</li> <li>Leggings</li> <li>8Cm Circular Fenestration</li> </ul>	160x280
CP 141066-000	1 PC	Carry Bag	







# Cardiology Packs & Drapes

- **Single Drapes**
- **Cardiovascular Packs**
- **Pacemaker Packs**
- **Angiography Packs**
- **Perineal Packs**
- **Cathlab Packs**



**PERINEAL DRAPE**

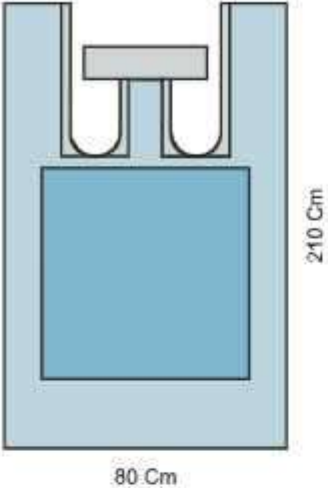

Product Code #	Description	Size(cm)
42012-0000	Perineal Drape <ul style="list-style-type: none"> <li>• Absorbent Laminated Reinforcement</li> <li>• Adhesive</li> <li>• 10x25 Cm Spit</li> </ul>	210x80

**FENESTRATED DRAPE**

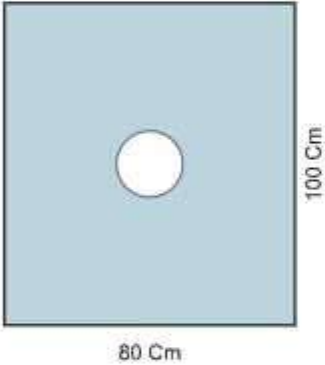

Product Code #	Description	Size(cm)
043-080-100S	Fenestrated Drape <ul style="list-style-type: none"> <li>• 20 Cm Circular Fenestration</li> </ul>	100x80



**ANGIO DRAPE**

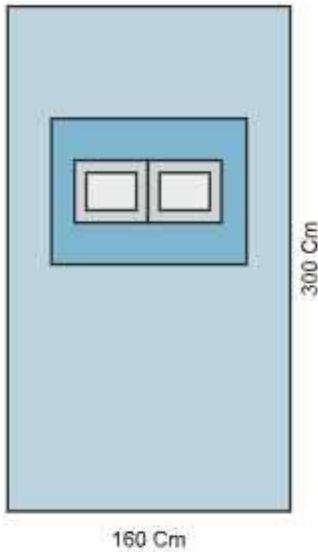

Product Code #	Description	Size(cm)
30011-0000	Angio Drape <ul style="list-style-type: none"> <li>• 13x13 Cm Fenestration</li> <li>• Absorbent Laminated Reinforcement</li> <li>• Adhesive</li> </ul>	160x300

**RADIAL DRAPE**

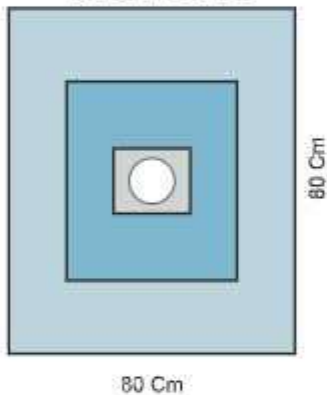

Product Code #	Description	Size(cm)
41103-0000	Radial Drape <ul style="list-style-type: none"> <li>• 6 Cm Circular Fenestration</li> <li>• Absorbent Laminated Reinforcement</li> <li>• Adhesive</li> </ul>	80x80

**SURGICAL SHEET WITH ABSORBENT REINFORCEMENT**

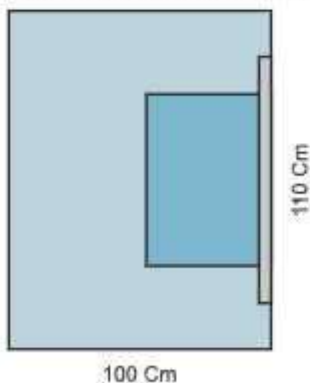

Product Code #	Description	Size(cm)
40014-0000	Surgical Sheet with Absorbent Reinforcement <ul style="list-style-type: none"> <li>• Absorbent Laminated Reinforcement</li> <li>• Adhesive</li> </ul>	100x110



**CABG DRAPE**

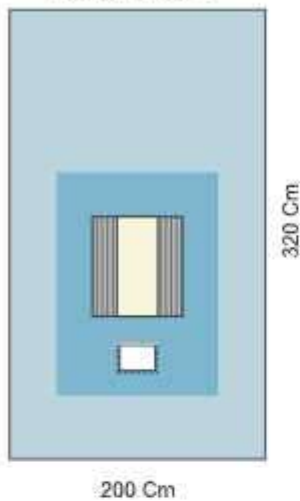

Product Code #	Description	Size(cm)
42001-0000	CABG Drape <ul style="list-style-type: none"> <li>• Absorbent Laminated reinforcement</li> <li>• Adhesive</li> <li>• Fluid Collection Pouch</li> <li>• Incise</li> <li>• 45x20 fenestration</li> </ul>	320x200

**BILATERAL UNDER LEG DRAPE**

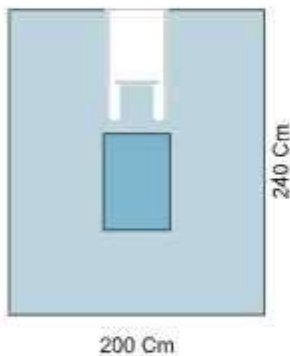

Product Code #	Description	Size(cm)
42011-0000	Bilateral Under Drape <ul style="list-style-type: none"> <li>• Absorbent Laminated reinforcement</li> <li>• Adhesive</li> </ul>	240x200

**SCREEN SHEET**

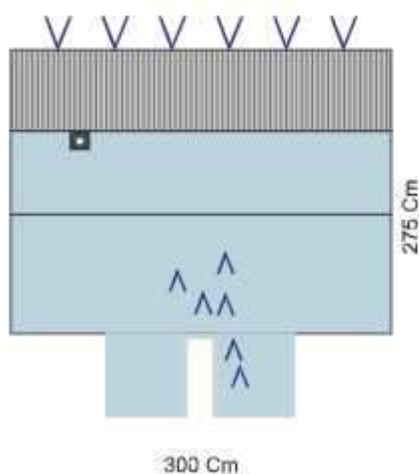

Product Code #	Description	Size(cm)
CR 143065-000	Screen Sheet <ul style="list-style-type: none"> <li>• Transparent plastic</li> <li>• Adhesive</li> </ul>	300x275



## FEMORAL DRAPE

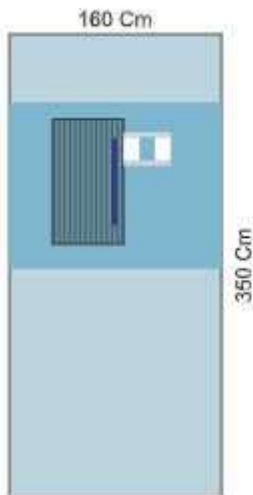

BACK VIEW

Product Code #	Description	Size(cm)
41104-0000	Femoral Drape <ul style="list-style-type: none"> <li>• Absorbent Laminated reinforcement</li> <li>• Adhesive</li> <li>• Fluid Collection Pouch</li> </ul>	160x350

## FEMORAL ANGIOGRAPHY DRAPE

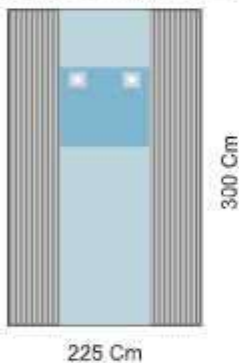

225 Cm

Product Code #	Description	Size(cm)
41105-0000	Femoral Angiography Drape <ul style="list-style-type: none"> <li>• Absorbent Laminated reinforcement</li> <li>• Adhesive</li> <li>• Transparent Plastic Windows</li> <li>• 8 cm circular fenestration</li> </ul>	300x225

## PACE MAKER DRAPE

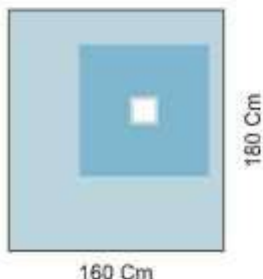

160 Cm

Product Code #	Description	Size(cm)
41110-0000	Pace Maker Drape <ul style="list-style-type: none"> <li>• Absorbent Laminated reinforcement</li> <li>• Adhesive</li> <li>• 8 cm square fenestration</li> </ul>	160x180





## RADIAL FEMORAL ANGIOGRAPHY DRAPE

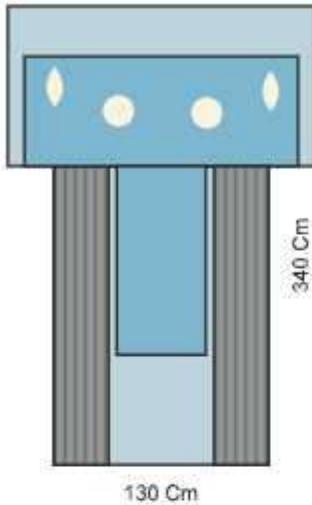

Product Code #	Description	Size(cm)
41103-0000	Radial Femoral Angiography Drape <ul style="list-style-type: none"> <li>• 13 Cm Circular Fenestration</li> <li>• 9Cm Oval Fenestration</li> <li>• Absorbent Laminated Reinforcement</li> <li>• Incise</li> <li>• Milpoly Clear Plastic Windows</li> </ul>	130x340

## RADIAL DRAPE

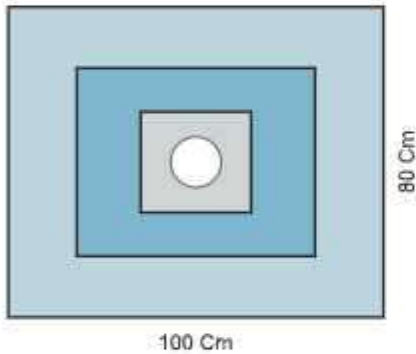

Product Code #	Description	Size(cm)
41102-0000	Radial Drape <ul style="list-style-type: none"> <li>• 7Cm Circular Fenestration</li> <li>• Absorbent Laminated Reinforcement</li> <li>• Adhesive</li> </ul>	100x80

## FEMORAL ANGIOGRAPHY DRAPE

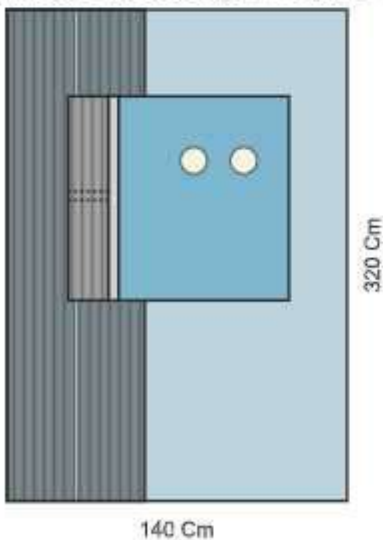

Product Code #	Description	Size(cm)
30011-0000	Femoral Angiography Drape <ul style="list-style-type: none"> <li>• Absorbent Laminated Reinforcement</li> <li>• 13Cm Circular Fenestration</li> <li>• Incise</li> <li>• Clear Plastic Windows</li> </ul>	140x320



## CABG Pack-I : Product Code - #66201-0001

**CABG DRAPE**

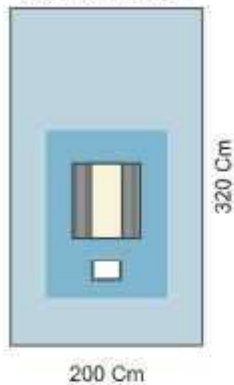

**BILATERAL UNDER LEG DRAPE**

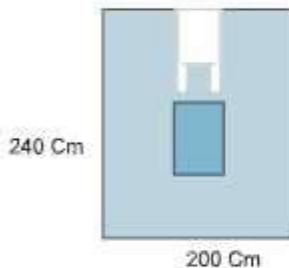

**CONE SHAPE FOOT COVER**

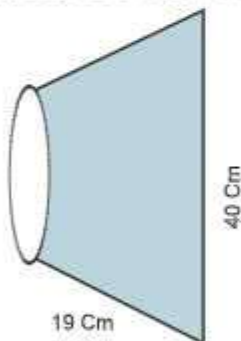

Item Code	Qty.	Contents	Size(cm)
085-160-225S	1 PC	Back Table Cover Reinforced	160x225
CR 143027-002	4 PCS	Surgical Gown GR 10	M
CR 143029-000	8 PCS	Hand Towels	
CR 143027-015	1 PC	Surgical Gown GR 10	L
CR 143029-000	2 PCS	Hand Towels	
42011-0000	1 PC	BI-Lateral Underleg Drape	240x200
		<ul style="list-style-type: none"> <li>• Adhesive</li> <li>• Absorbent Laminated Reinforcement</li> <li>• 10x25 Cm Split</li> </ul>	
043-160-160A	1 PC	Medium Drape with Adhesive	160x160
		<ul style="list-style-type: none"> <li>• Adhesive</li> </ul>	
42001-0000	1 PC	Cardiovascular Drape	200x280
		<ul style="list-style-type: none"> <li>• Adhesive</li> <li>• Incise</li> <li>• Absorbent Laminated Reinforcement</li> <li>• 45x20 Cm Fenestration</li> </ul>	
CC 142002-000	2 PCS	Cautery Bag	30x30
CC 142002-003	1 PC	Suture Bag	10x5
CC 142035-005	2 PC	Foot Cover Cone Shape	
CC 142043-001	2 PCS	ISO Seal Drape Tape Strips	45x5
065-050-050S	2 PCS	Absorbent Laminated Reinforcement	50x50
060-100-100S	1 PC	Absorbent Laminated Reinforcement	100x100
318-240-240S	1 PC	Trolley Sheet Large	240x240
085-160-125S	2 PCS	Trolley Sheet Medium	160x125
043-080-080A	1 PC	Surgical Sheet	80x80
		<ul style="list-style-type: none"> <li>• Adhesive</li> <li>• Absorbent Laminated Reinforcement</li> </ul>	75x75
40015-0000	1 PC	Surgical Sheet Medium	
		<ul style="list-style-type: none"> <li>• Adhesive</li> <li>• Absorbent Laminated Reinforcement</li> </ul>	160x120
40016-0000	1 PC	Surgical Sheet Small	100x100
		<ul style="list-style-type: none"> <li>• Adhesive</li> <li>• Absorbent Laminated Reinforcement</li> </ul>	75x75
CR 142043-000	1 PC	ISO Seal Drape Tape Strips	10x45
CC 142035-005	1 PC	Hand Cover Cone Shape	
40111-0000	2 PCS	Small Fenestrated Sheet	100x80
		<ul style="list-style-type: none"> <li>• 8 Cm Circular Fenestration</li> <li>• Absorbent Laminated Reinforcement</li> </ul>	40x40
043-080-100A	3 PCS	Surgical Sheet Small	100x80
		<ul style="list-style-type: none"> <li>• Adhesive</li> </ul>	
043-080-100S	1 PC	Surgical Sheet Small	100x80
CP 141066-000	1 PC	Carry Bag	



## CABG Pack-II : Product Code - #66201-0002

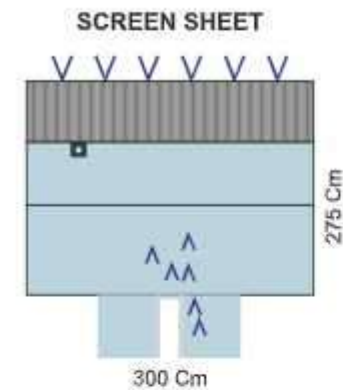

CONE SHAPE FOOT COVER

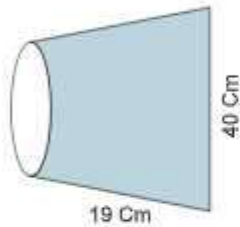

Item Code	Qty.	Contents	Size(cm)
085-160-225S	1 PC	Back Table Cover Reinforced	160x225
043-045-020A	1 PC	Perineal Sheet	45x20
043-1600-180S	1 PC	Bottom Drape	160x180
CC 142035-005	2 PCS	Foot Cover Cone Shape	80x80
CC 142043-001	5 PCS	ISO Seal Drape Tape Strips	5x45
043-045-500A	4 PCS	Chest Drape with Adhesive	45x50
043-080-100A	2 PCS	Side Drape with Adhesive	100x80
043-160-100S	1 PC	Abdominal Drape	160x100
043-160-100S	1 PC	Top Drape	160x100
CR 143065-000	1 PC	Screen Sheet	275x300
CR 142002-004	1 PC	Clear Plastic	
CR 142002-004	1 PC	Cautery Bag	35x25
CR 142002-003	1 PC	Cautery Bag	20x25
CC 142007-000	1 PC	Pump Sheet Carry Plastic 40 Micron	150x150
CP 141066-000	1 PC	Garry Bag	

## Pace Maker Pack I : Product Code - #666731-0001

PACE MAKER DRAPE

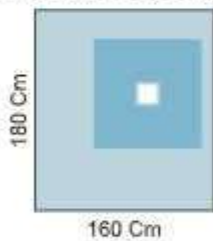

SURGICAL SHEET SMALL

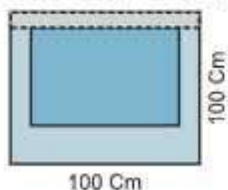

Item Code	Qty.	Contents	Size(cm)
085-160-100S	1 PC	Back Table Cover Reinforced	160x100
CR 143027-030	3 PCS	Surgical Gown Reinforced	L
CR 143029-000	3 PCS	Hand Towels	30x30
318-160-160S	1 PC	Trolley Sheet Laminated Reinforced	160x160
40018-0000	4 PCS	Surgical Sheet with Absorbent Reinforcement	100x110
043-160-200S	1 PC	Surgical Sheet	160x200
41110-000	1 PC	Pacemaker Drape	160x180
CP 141066-000	1 PC	Carry Bag	





## Pace Maker Pack II : Product Code - #66731-0002

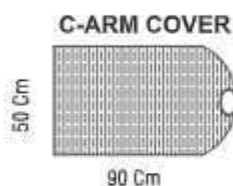
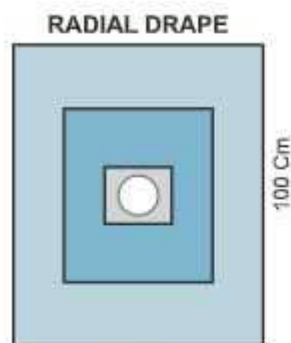

Item Code	Qty.	Contents	Size(cm)
318-160-080S	1 PC	Back Table Cover Reinforced	160x80
CR 143027-027	2 PCS	Over Lap Gown	L
CR 143029-000	2 PCS	Hand Towel	30x30
41102-0000	1 PC	Radial Drape	100x80
		<ul style="list-style-type: none"> <li>• 7 Cm Circular Fenestration</li> <li>• Absorbent Laminated Reinforcement</li> <li>• Adhesive</li> </ul>	
085-160-125S	1 PC	Trolley Sheet	160x125
CR 143024-006	10 PCS	Gauze Swab X-Ray Detectable	7.5x7.5
CC 142001-000	1 PC	C-Arm Cover Transparent	50x90
CP 141066-000	1 PC	Carry Bag	

## Pace Maker Pack III : Product Code - #66731-0003

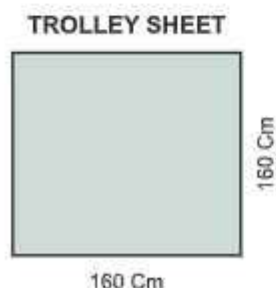
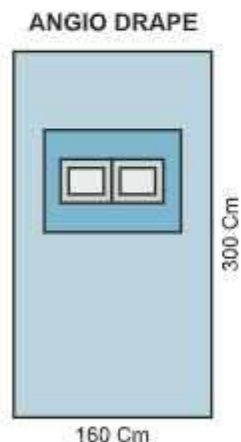

Item Code	Qty.	Contents	Size(cm)
085-160-100S	1 PC	Back Table Cover Reinforced	160x100
CR 143027-024	3 PCS	Surgical Gown	L
CR 143029-000	3 PCS	Hand Towel	30x30
318-160-160S	1 PC	Trolley Sheet Laminated Reinforcement	160x160
30011-0000	1 PC	Angio Drape	160x300
		<ul style="list-style-type: none"> <li>• 13x13 Cm Square Fenestration</li> <li>• Absorbent Laminated Reinforcement</li> <li>• Adhesive</li> </ul>	
CP 141066-000	1 PC	Carry Bag	





## Radial Femoral Angiography Pack : Product Code - #66702-0000

### RADIAL FEMORAL ANGIOGRAPHY DRAPE

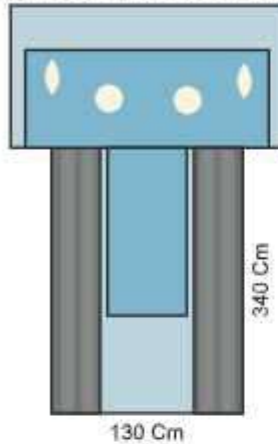

### FLUROSCOPY COVER

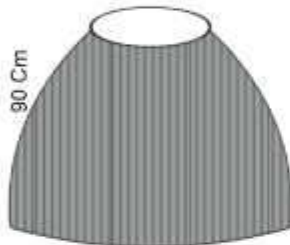

### ANGIO PROTECTION COVER

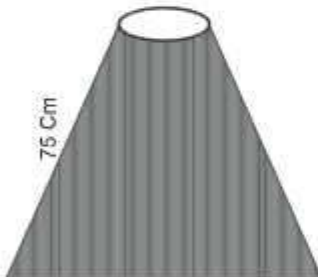

Item Code	Qty.	Contents	Size(cm)
085-160-100S	1 PC	Back Table Cover Reinforced	160x100
CR 143027-030	2 PCS	Surgical Gown Reinforced	L
CR 143029-000	2 PCS	Hand Towel	30x30
CC 142014-003	1 PC	Fluroscopy Cover	90x90
CC 142014-000	1 PC	Angio Protection Cover	85x75
CP 141081-002	1 PC	Bowl 500 CC	
CP 141081-003	1 PC	Bowl 1000 CC	
CR 143130-000	1 PC	Sponge Stick Blue 15 Cm	
CP 141081-006	1 PC	Half Deep Tray 10x25 Cm	
CR 143041-012	6 PCS	Mopping Pad	30x30
41103-0000	1 PC	Radial Femoral Angiography Drape	
		<ul style="list-style-type: none"> <li>Absorbent Laminated Reinforcement</li> <li>Incise</li> <li>13 Circular Fenestration</li> <li>9 Cm Oval Fenestration</li> <li>Milpoly Clear Plastic Windows</li> </ul>	40 Microns
085-160-125S	1 PC	Trolley Sheet	160x125
CP 141066-000	1 PC	Carry Bag	

## Femoral Angiogram Pack I : Product Code - #66011-0001

### ANGIO DRAPE

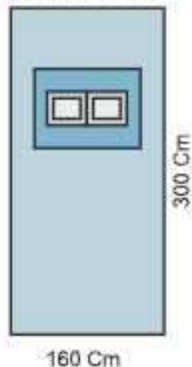

Item Code	Qty.	Contents	Size(cm)
318-080-100S	1 PC	Back Table Cover Reinforced	100x80
318-160-160S	1 PC	Trolley Sheet	160x160
30011-0000	1 PC	Angiogram Drape	160x300
		<ul style="list-style-type: none"> <li>Absorbent Laminated Reinforcement</li> </ul>	160x300
CP 141066-000	1 PC	Carry Bag	



## Femoral Angiography Pack II : Product Code - #66011-0002

### FEMORAL ANGIOGRAPHY DRAPE

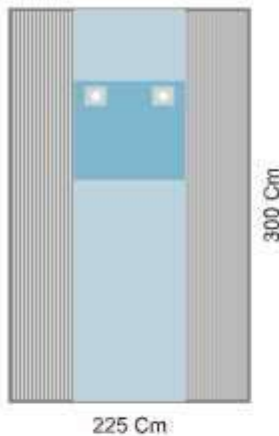

Item Code	Qty.	Contents	Size(cm)
085-160-125S	1 PC	Back Table Cover Reinforced	160x125
CR 143027-024	2 PCS	Surgical Gown	L
CR 143029-000	2 PCS	Hand Towel	30x30
CP 141081-005	2 PCS	Kidney Basin	
CR 143041-012	6 PCS	Mopping Pad	30x30
41105-0000	1 PC	Femoral Angiography Drape	225x300
		<ul style="list-style-type: none"> <li>• 7 Cm Circular Fenestration</li> <li>• Absorbent Laminated Reinforcement</li> <li>• Incise</li> <li>• Clear Plastic Windows 40 Microns</li> </ul>	
085-160-125S	1 PC	Trolley Sheet	160x125
CP 141066-000	1 PC	Carry Bag	

### TROLLEY SHEET

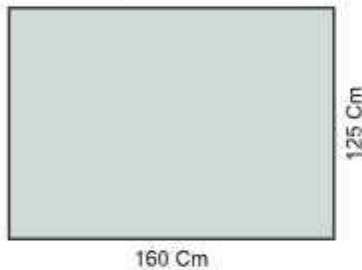

## Femoral Angiography Pack III : Product Code - #66011-0003

### FEMORAL ANGIOGRAPHY DRAPE

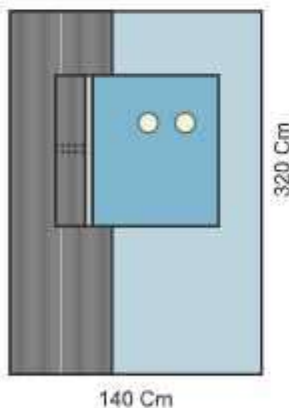

Item Code	Qty.	Contents	Size(cm)
085-160-100S	1 PC	Back Table Cover Reinforced	160x100
CR 143027-027	2 PCS	Surgical Gown Overlap	L
CR 143029-000	2 PCS	Hand Towel	30x30
30011-0000	1 PC	Angiography Drape	140x320
		<ul style="list-style-type: none"> <li>• Absorbent Laminated Reinforcement</li> <li>• 13 Cm Circular Fenestration</li> <li>• Incise</li> <li>• Clear Plastic Window</li> </ul>	
318-160-160S	1 PC	Trolley Sheet Laminated Reinforced	160x160
CR 143041-012	6 PCS	Mopping Pad	30x30
CP 141066-000	1 PC	Carry Bag	

### TROLLEY SHEET

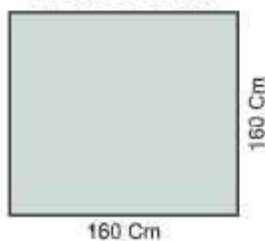

## Perineal Pack I : Product Code - #66581-0001

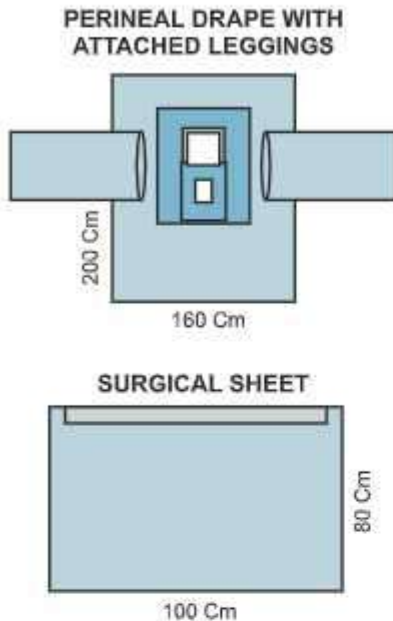

Item Code	Qty.	Contents	Size(cm)
085-160-100S	1 PC	Back Table Cover Reinforced	160x100
CR 143027-038	3 PCS	Surgical Gown Wrap Around	L
CR 143029-000	3 PCS	Hand Towels	30x30
318-160-160S	2 PCS	Trolley Sheet Laminated Reinforced	160x160
043-080-100A	2 PCS	Surgical Sheet	100x80
43101-0000	1 PC	Perineal Drape with Attached Leggings <ul style="list-style-type: none"> <li>• 15 x20 Cm Perineal Fenestration</li> <li>• 30x30 Abdominal Fenestration</li> <li>• Absorbent Laminated Reinforcement</li> <li>• Adhesive</li> <li>• Leggings</li> </ul>	160x200
CP 141066-000	1 PC	Carry Bag	

## Perineal Pack II : Product Code - #66581-0002

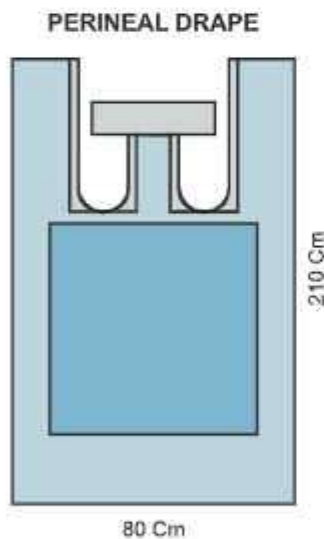

Item Code	Qty.	Contents	Size(cm)
085-160-125S	1 PC	Back Table Cover Reinforced	160x125
CR 143027-024	2 PCS	Surgical Gown	L
CR 143029-000	2 PCS	Hand Towels	30x30
043-080-100S	2 PCS	Surgical Sheet Medium	100x80
043-080-100S	1 PC	Fenestrated Sheet	100x80
CC 142005-000	2 PCS	Leggings	100x80
42012-0000	1 PC	Perineal Drape <ul style="list-style-type: none"> <li>• Absorbent Laminated Reinforcement</li> <li>• Adhesive</li> <li>• 10x25 Cm Split</li> </ul>	210x200
318-160-200S	1 PC	Trolley Sheet Laminated Reinforcement	160x200
CR 143041-012	6 PCS	Mopping Pad	30x30
CP 141066-000	1 PC	Carry Bag	

### FENESTRATED DRAPE

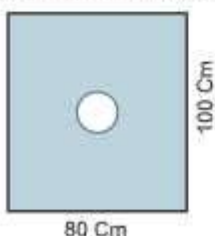



## Cath Lab Pack : Product Code - #66021-0000

### FEMORAL DRAPE

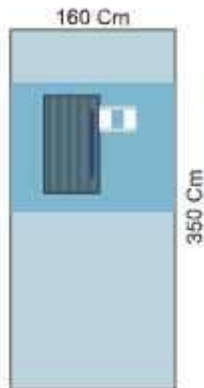

BACK VIEW

Item Code	Qty.	Contents	Size(cm)
318-080-100S	1 PC	Back Table Cover Reinforced	100x80
CR 143027-031	2 PCS	Surgical Gown Reinforced	M
CR 143029-000	2 PCS	Hand Towels	30x30
060-160-240S	1 PC	Laminated Absorbent Sheet	160x240
41104-0000	1 PC	Femoral Drape <ul style="list-style-type: none"> <li>• 13x10 Cm Fenestration</li> <li>• Absorbent Laminated Reinforcement</li> <li>• Adhesive</li> <li>• Fluid Collection Pouch</li> </ul>	
CP 141066-000	1 PC	Carry Bag	

### LAMINATED ABSORBENT SHEET

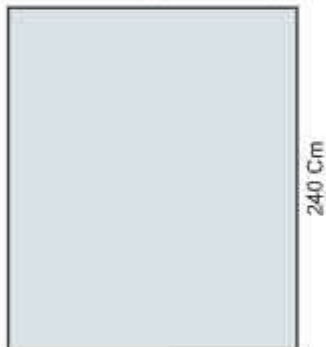

160 Cm





## Coronary Artery By Pass Pack : Product Code - #66202-0000

**CABG DRAPE**

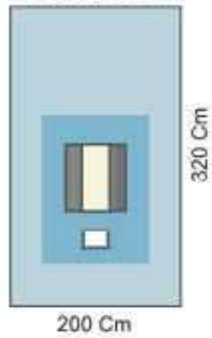

**BILATERAL UNDER LEG DRAPE**

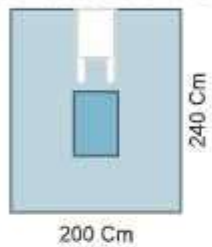

**DAITHERMY BAG**

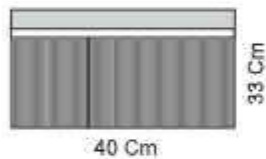

Item Code	Qty.	Contents	Size(cm)
085-160-225S	1 PC	Back Table Cover Reinforced	160x225
CR 143029-000	4 PC	Hand Towels	30x30
CR 143039-000	1 PC	Mayo Cover Reinforced	80x80
CR 142043-000	2 PC	ISO Seal Drape Tape Strips	10x45
043-160-100A	1 PC	Surgical Sheet with Adhesive	160x100
085-160-125S	1 PC	Trolley Sheet	160x125
42012-0000	1 PC	Bi-Lateral Underleg Drape	
		<ul style="list-style-type: none"> <li>• Adhesive</li> <li>• Absorbent Laminated Reinforcement</li> <li>• 10x25 Cm Split</li> </ul>	
CP 1443086-002	2 PC	Tube Holder with Velcro	5x25
		<ul style="list-style-type: none"> <li>• Adhesive</li> <li>• Velcro</li> </ul>	
CR 142002-001	1 PC	Diathermy Bag	30x35
		<ul style="list-style-type: none"> <li>• Adhesive</li> </ul>	
CR 143041-012	6 PC	Mopping Pad	30x30
42001-0000	1 PC	Cardio vascular Drape with Pockets	
		<ul style="list-style-type: none"> <li>• Adhesive</li> <li>• Incise</li> <li>• Absorbent Laminated Reinforcement</li> <li>• 45x20 Cm Fenestration</li> <li>• Pockets</li> </ul>	
CP 141066-000	1 PC	Carry Bag	





# Orthopedic Packs & Drapes

- **Single Drapes**
- **Ortho Packs**
- **HIP Packs**
- **Arthroscopy Packs**
- **Vertical Isolation Packs**
- **Spinal Packs**
- **Knee Packs**

## UPPER EXTREMELY DRAPE

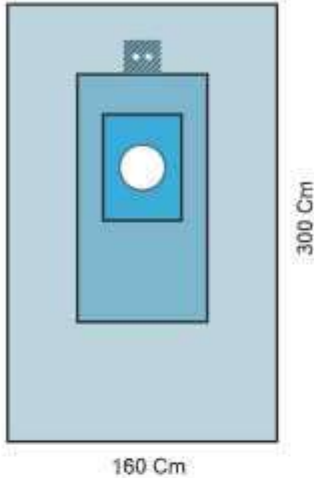

Product Code #	Description	Size(cm)
44001-0000	Upper Extremity Drape <ul style="list-style-type: none"> <li>• Absorbent Laminated Reinforcement</li> <li>• Tube Holder</li> </ul>	160x300

## EXTREMITY PREP PAD

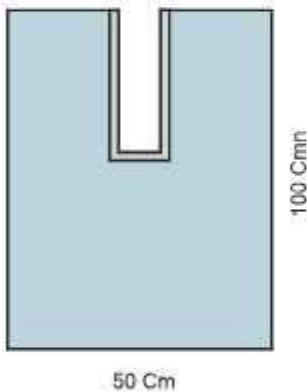

Product Code #	Description	Size(cm)
41016-0000	Extremity Prep Pad <ul style="list-style-type: none"> <li>• Absorbent Laminated Reinforcement</li> <li>• Adhesive</li> <li>• 10x32 Cm Split</li> </ul>	100x50

## IMPERVIOUS SPLIT SHEET

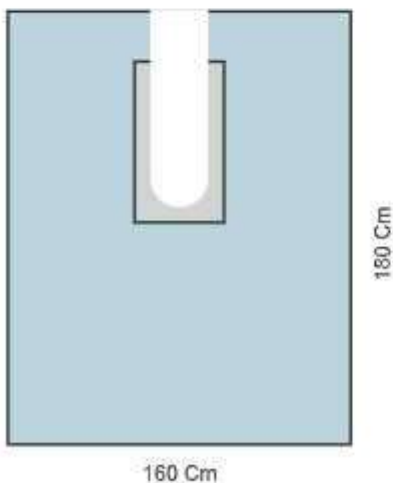

Product Code #	Description	Size(cm)
41015-0000	Impervious Split Sheet <ul style="list-style-type: none"> <li>• Adhesive</li> <li>• 10x53 Cm Split</li> </ul>	160x180



## BILATERAL KNEE-O-DRAPE

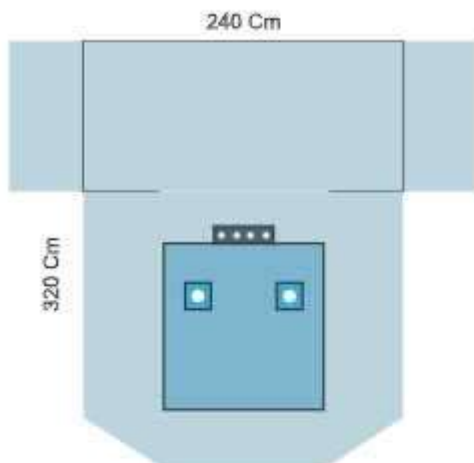

Product Code #	Description	Size(cm)
30306-0000	Bilateral Knee-O-Drape <ul style="list-style-type: none"> <li>• Absorbent Laminated reinforcement</li> <li>• Tube holder</li> </ul>	240x320

## HIP DRAPE WITH FLUID COLLECTION POUCH

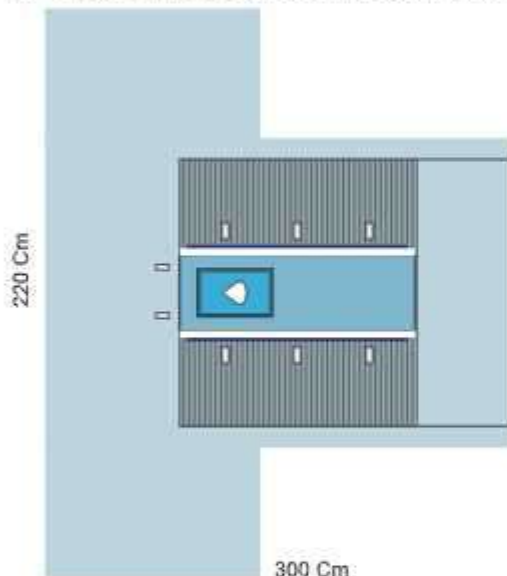

Product Code #	Description	Size(cm)
30291-0000	Hip Drape with Fluid Collection Pouch <ul style="list-style-type: none"> <li>• Absorbent Laminated reinforcement</li> <li>• Tube holder</li> <li>• Velcro</li> </ul>	220x300

## DHS DRAPE LARGE

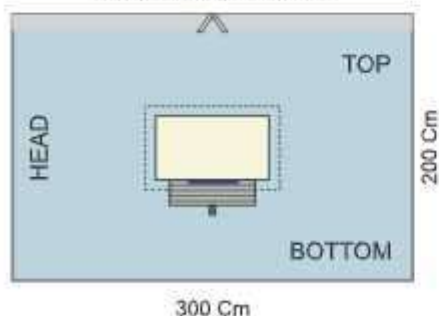

Product Code #	Description	Size(cm)
30241-0000	DHS Drape Large <ul style="list-style-type: none"> <li>• Transparent Plastic</li> <li>• Incise</li> <li>• Fluid Collection Pouch</li> <li>• Adhesive</li> <li>• 30x70 fenestration</li> </ul>	200x300





## ARTHROSCOPY DRAPE

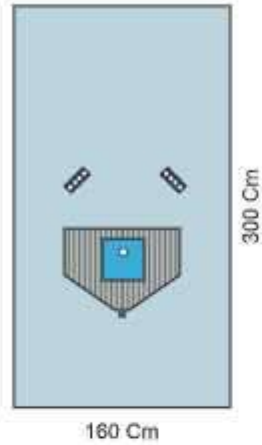

Product Code #	Description	Size(cm)
30101-0000	Arthroscopy Drape <ul style="list-style-type: none"> <li>• Fluid Collection Pouch</li> <li>• Tube holder</li> </ul>	160x300

## KNEE ARTHROSCOPY

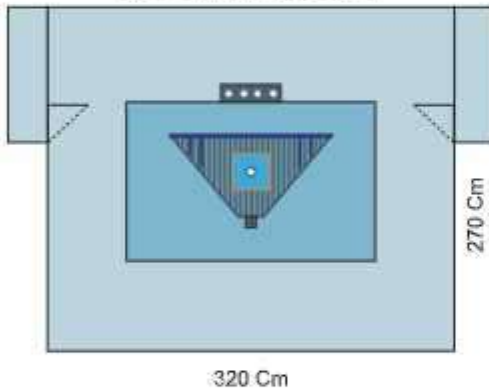

Product Code #	Description	Size(cm)
30104-0000	Knee Arthroscopy <ul style="list-style-type: none"> <li>• Absorbent Laminated Reinforcement</li> <li>• Tube holder</li> <li>• Fluid Collection Pouch</li> </ul>	320x270

## HIP-U-DRAPE

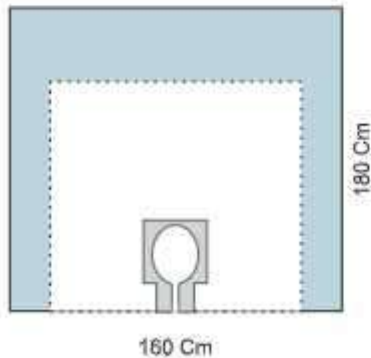

Product Code #	Description	Size(cm)
30292-0000	Hip-U-Drape <ul style="list-style-type: none"> <li>• Hygiene Sheet</li> <li>• Adhesive</li> </ul>	180x160



**LAMINO SPINAL DRAPE**

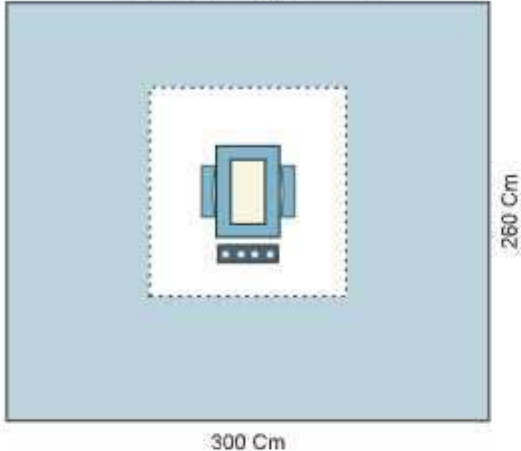

Product Code #	Description	Size(cm)
30251-0001	Lamino Spinal Drape <ul style="list-style-type: none"> <li>• Absorbent Laminated reinforcement</li> <li>• Hygiene Sheet</li> <li>• Tube holder</li> <li>• Incise</li> </ul>	300x260

**SPLIT U DRAPE**

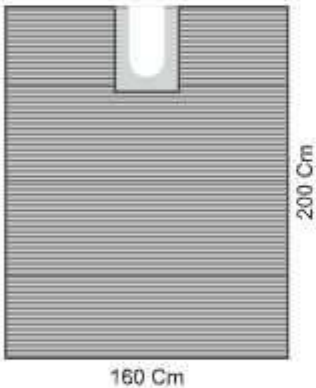

Product Code #	Description	Size(cm)
30331-0000	Split-U-Drape <ul style="list-style-type: none"> <li>• Transparent Plastic</li> <li>• Adhesive</li> </ul>	200x160



**ORTHO U DRAPE**

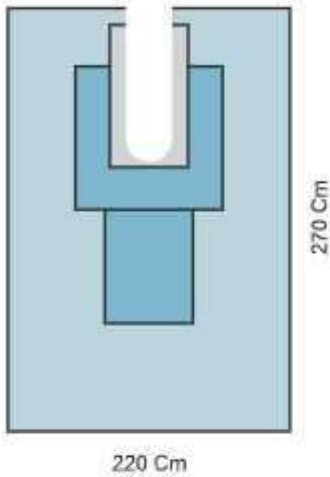

Product Code #	Description	Size(cm)
41014-0000	Ortho U Drape <ul style="list-style-type: none"> <li>• 10x100 Cm Split</li> <li>• Absorbent Laminated Reinforcement</li> <li>• Adhesive</li> </ul>	270x220

**BAR DRAPE**

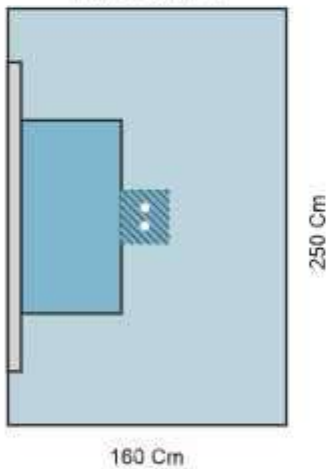

Product Code #	Description	Size(cm)
41013-0000	Bar Drape <ul style="list-style-type: none"> <li>• Absorbent Laminated Reinforcement</li> <li>• Tube Holder</li> <li>• Adhesive</li> </ul>	160x250



## SHOULDER ARTHROSCOPY DRAPE

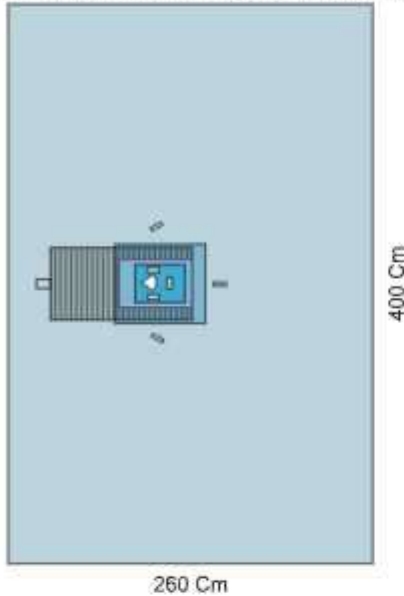

Product Code #	Description	Size(cm)
30121-0000	Shoulder Arthroscopy Drape <ul style="list-style-type: none"> <li>• Absorbent Laminated reinforcement</li> <li>• Adhesive</li> <li>• Fluid Collection Pouch</li> <li>• Velcro</li> </ul>	260x400

## SHOULDER ARTHROSCOPY LATERAL

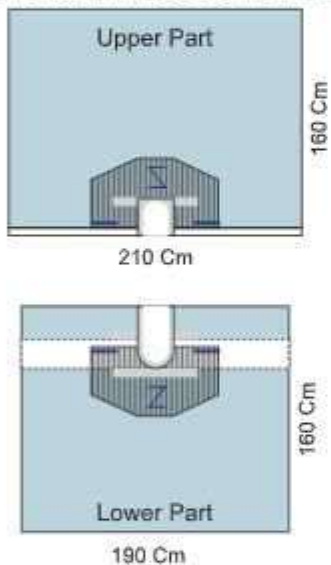

Product Code #	Description	Size(cm)
30151-0000	Shoulder Arthroscopy Lateral <ul style="list-style-type: none"> <li>• Absorbent fabric</li> <li>• Adhesive</li> <li>• Fluid Collection Pouch</li> <li>• Velcro</li> </ul>	210x160

Product Code #	Description	Size(cm)
30151-0000	Shoulder Arthroscopy Lateral <ul style="list-style-type: none"> <li>• Absorbent fabric</li> <li>• Adhesive</li> <li>• Fluid Collection Pouch</li> <li>• Velcro</li> </ul>	160x190

## UNIVERSAL EXTREMITY DRAPE

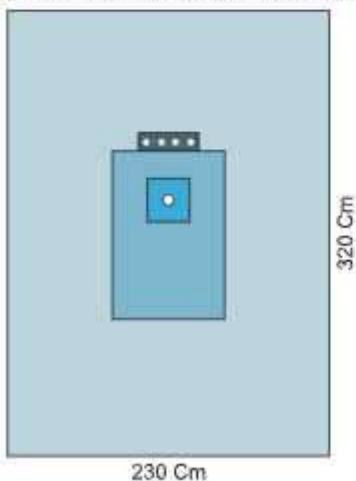

Product Code #	Description	Size(cm)
44004-0000	Universal Extremity Drape <ul style="list-style-type: none"> <li>• Absorbent Laminated reinforcement</li> <li>• Tube holder</li> </ul>	230x320





## LEG-O-DRAPE

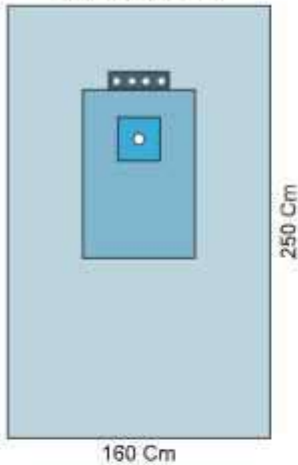

Product Code #	Description	Size(cm)
44002-0000	Leg-O-Drape <ul style="list-style-type: none"> <li>Absorbent Laminated reinforcement</li> <li>Tube holder</li> </ul>	160x250

## LEG-U-DRAPE

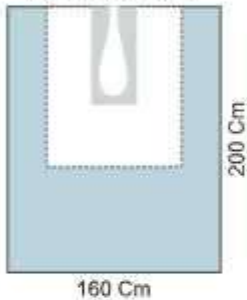

Product Code #	Description	Size(cm)
30271-0000	Leg-U-Drape <ul style="list-style-type: none"> <li>Hygiene Sheet</li> <li>Adhesive</li> </ul>	160x200

## KNEE-O-PREMIUM

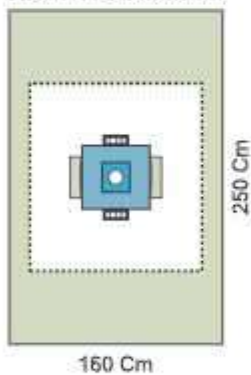

Product Code #	Description	Size(cm)
30301-0000	Knee-O-Drape Premium <ul style="list-style-type: none"> <li>Absorbent Laminated reinforcement</li> <li>Hygiene Sheet</li> <li>Tube Holder</li> <li>Pockets</li> </ul>	160x250

## HAND DRAPE WITH ARM BOARD COVERS

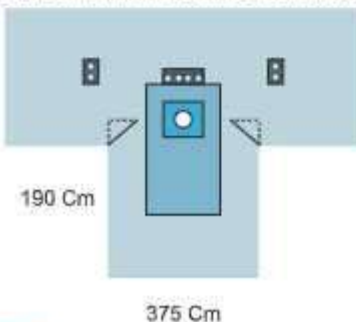

Product Code #	Description	Size(cm)
44012-0000	Hand Drape with Arm Board Covers <ul style="list-style-type: none"> <li>Absorbent Laminated reinforcement</li> <li>Tube Holder</li> <li>Arm Board Covers</li> </ul>	375x190



## Ortho Pack I : Product Code - #66361-0001

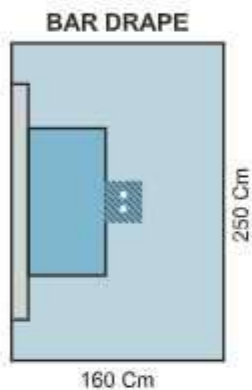
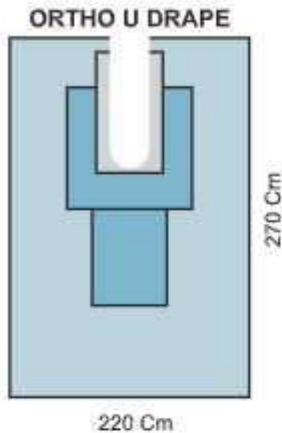

Item Code	Qty.	Contents	Size(cm)
318-160-200S	1 PC	Back Table Cover Reinforced	160x200
CR 143027-030	2 PCS	Surgical Gown Reinforced	L
CR 143029-000	2 PCS	Hand Towel	30x30
CR 143030-000	1 PC	Mayo Stand Cover Reinforced	80x80
043-040-060A	4 PCS	Utility Drape	60x40
		• Adhesive	
CC 142002-003	1 PC	Suture Bag	
41015-0000	1 PC	Impervious Split Sheet	160x180
		• 10x52 Cm Split	
		• Adhesive	
085-160-230S	1 PC	Trolley Sheet Laminated Reinforced	160x230
CR 143079-000	1 PC	Stockinette	L20x20
41014-0000	1 PC	Ortho U" Drape	270x220
		• 10x100 Cm Split	
		• Absorbent Laminated Reinforcement	
		• Adhesive	
41013-0000	1 PC	Ortho Bar Drape	160x250
		• Absorbent Laminated Reinforcement	
		• Tube Holder	
		• Adhesive	
CP 141066-000	1 PC	Carry Bag	

## Ortho Pack II : Product Code - #66361-0002

### UPPER EXTREMELY DRAPE

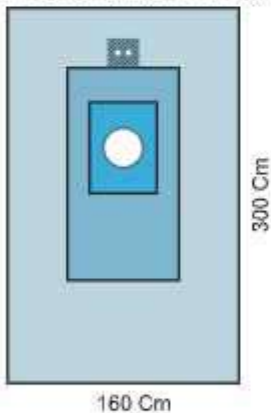

### IMPERVIOUS SPLIT SHEET

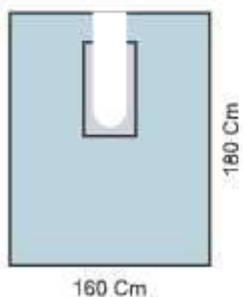

Item Code	Qty.	Contents	Size(cm)
085-160-125S	1 PC	Back Table Cover Reinforced	160x125
CR 143027-038	4 PCS	Surgical Gown Wrap Around	L
CR 143029-000	4 PCS	Hand Towel	30x30
318-160-200S	1 PC	Trolley Sheet	160x200
043-163-200A	2 PCS	Surgical Drape with Adhesive	160x200
		• Adhesive	
043-120-080A	3 PCS	Surgical Drape with Adhesive	120x80
		• Adhesive	
CR 143041-012	3 PCS	Mopping Pad	30x30
CR 143005-000	2 PCS	Apron	XL
41015-0000	1 PC	Impervious Split Sheet	160x180
44001-0000	1 PC	Upper Extremity Drape	160x300
		• Absorbent Laminated Reinforcement	
		• Tube Holder	
CR 143079-000	1 PC	Stockinette	L20x20
CR 142043-000	3 PCS	ISO Seal Drape Tape Strips	10x45
CP 141066-000	1 PC	Carry Bag	



## Ortho Pack III : Product Code - #66361-0003

HIP-U-DRAPE

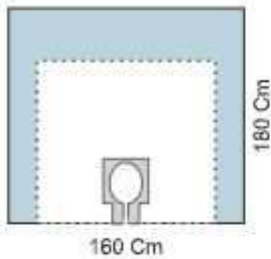

Surgical Sheet

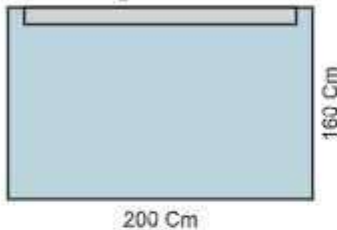

Item Code	Qty.	Contents	Size(cm)
085-160-125S	1 PC	Back Table Cover Reinforced	160x125
CR 143027-038	5 PCS	Surgical Gown Wrap Around	L
CR 143029-000	5 PCS	Hand Towel	30x30
043-160-200A	2 PCS	Surgical Drape	160x200
CR 143079-000	1 PC	Stockinette	L20x200
30292-0000	1 PC	HIP U* Drape	180x160
		<ul style="list-style-type: none"> <li>• Hygiene Sheet</li> <li>• Adhesive</li> <li>• 30x24 Cm Oval Fenestration</li> </ul>	
CR 143041-012	3 PCS	Mopping Pad	30x30
CR 143005-000	2 PCS	Apron	XL
CR 143080-004	3 PCS	Surgical Cap	
CR 143024-000	3 PCS	Face Mast with Eye Shield	
CP 141066-000	1 PC	Carry Bag	

## Ortho Pack IV : Product Code - #66361-0004

KNEE-O-PREMIUM

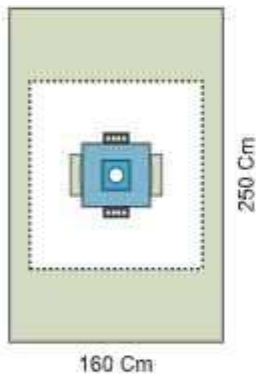

SURGICAL SHEET

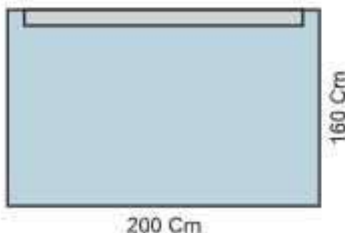

Item Code	Qty.	Contents	Size(cm)
085-160-125S	1 PC	Back Table Cover Reinforced	160x125
CR 143027-038	5 PCS	Surgical Gown Wrap Around	L
CR 143029-000	5 PCS	Hand Towel	30x30
043-160-200A	2 PCS	Surgical Drape	160x200
CR 143079-000	1 PC	Stockinette	L20x200
30301-0000	1 PC	Knee D* Drape	250x160
		<ul style="list-style-type: none"> <li>• Hygiene Sheet</li> <li>• Tube Holder</li> <li>• Pockets</li> </ul>	
CR 143041-012	3 PCS	Mopping Pad	30x30
CR 143013-000	1 PC	Cling Drape	
CR 143005-000	2 PCS	Apron	XL
CR 143080-004	3 PCS	Surgical Cap	
CR 142024-000	3 PCS	Face Mast with Eye Shield	
CP 141066-000	1 PC	Carry Bag	





## Arthroscopy Pack II : Product Code - #66101-0002

### ARTHROSCOPY DRAPE

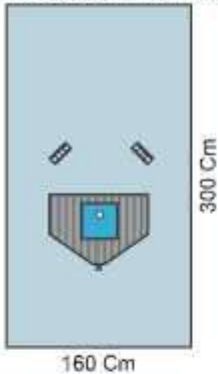

### CLING DRAPE



### APRON

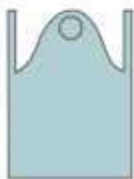

Item Code	Qty.	Contents	Size(cm)
085-160-200S	1 PC	Back Table Cover Reinforced	160x200
CR 143027-038	5 PCS	Surgical Gov'n Wrap Around	L
CR 143029-000	5 PCS	Hand Towel	30x30
30101-0000	1 PC	Arthroscopy Drape	160x300
		<ul style="list-style-type: none"> <li>• Fluid Collection Pouch</li> <li>• Tube Holder</li> </ul>	
CR 143010-002	3 PCS	Camera Cover	240x20
		<ul style="list-style-type: none"> <li>• Card Board Support</li> <li>• Adhesive with Release</li> </ul>	
CR 143013-000	1 PC	Cling Drape	
CR 143005-000	2 PCS	Apron	XL
CP 141066-000	1 PC	Carry Bag	

## Arthroscopy Pack III : Product Code - #66101-0003

### ARTHROSCOPY DRAPE

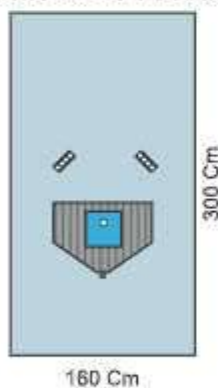

### CAUTERY BAG

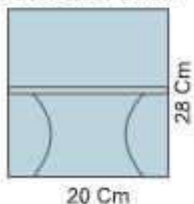

Item Code	Qty.	Contents	Size(cm)
085-080-100S	1 PC	Back Table Cover Reinforced	100x80
CR 143029-000	2 PCS	Hand Towel	30x30
CR 143013-000	1 PC	Cling Drape	
CR 143066-005	2 PCS	Shoe Cover	70x42
CR 143010-002	1 PC	Camera Cover	240x20
		<ul style="list-style-type: none"> <li>• Card Board Support</li> <li>• Adhesive with Release</li> </ul>	
CC 142002-000	1 PC	Cautery Bag	28x20
30101-0000	1 PC	Arthroscopy Drape	160x300
		<ul style="list-style-type: none"> <li>• Fluid Collection Pouch</li> <li>• Tube Holder</li> </ul>	
CP 141066-000	1 PC	Carry Bag	





## HIP Pack : Product Code - #66051-0000

### HIP DRAPE WITH FLUID COLLECTION POUCH

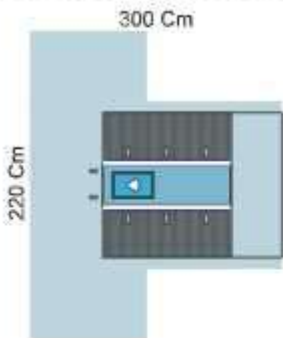

### IMPERVIOUS SPLIT SHEET

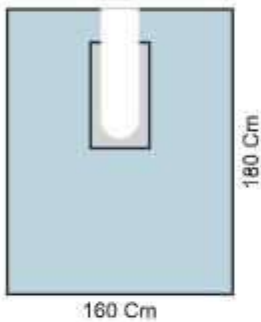

Item Code	Qty.	Contents	Size(cm)
318-160-180S	1 PC	Back Table Cover Reinforced	160x180
CR 143027-024	1 PC	Surgical Gown	L
CR 143029-000	1 PC	Hand Towel	30x30
CR 143027-030	2 PCS	Surgical Gown Reinforced	L
CR 143029-000	2 PCS	Hand Towels	30x30
CR 143029-000	1 PC	Mayo Stand Cover Reinforced	80x80
CC 142002-001	1 PC	Diathermy Bag	30x35
		• Adhesive	
CR 143079-000	1 PC	Stockinette	L 20x20
41015-0000	1 PC	Impervious Split Sheet	160x180
		• 10x25 Cm Split	
		• Adhesive	
043-160-200S	1 PC	Surgical Sheet	160x200
CR 143120-000	1 PC	Yankauer Tip	
CR 143123-000	1 PC	Suction Tubing 10" Feet	
CR 143005-000	1 PC	Apron	XL
CR 143013-000	1 PC	Cling Drape	
318-160-200S	1 PC	Trolley Sheet	160x200
30291-0000	1 PC	HIP Drape with Pockets	110x430
		• Fluid Collection Pouch	
		• Absorbent Laminated Reinforcement	
		• Arm Board Covers	
		• Tube Holder	
CP 141066-000	1 PC	Carry Bag	

## Arthroscopy Pack I : Product Code - #66101-0001

### KNEE ARTHROSCOPY

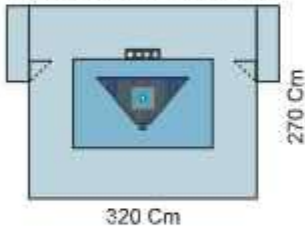

### CAMERA COVER



### EXTREMITY PREP PAD

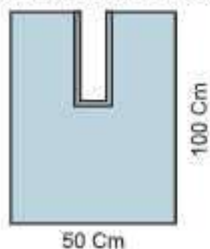

Item Code	Qty.	Contents	Size(cm)
318-160-200S	1 PC	Back Table Cover Reinforced	160x200
CR 143029-038	3 PCS	Surgical Gown Wrap Around	L
CR 143029-000	3 PCS	Hand Towel	30x30
CR 143027-030	2 PCS	Surgical Gown Reinforced	L
CR 143029-000	2 PCS	Hand Towels	30x30
41016-0000	1 PC	Extremity Prep Pad	100x50
		• Adhesive	
		• 10x32 Cm Split	
CR 143010-002	3 PCS	Camera Cover	240x20
		• Card Board Support	
		• Adhesive with Release	
CR 143013-000	1 PC	Cling Drape	
CR 143005-000	2 PCS	Apron	XL
CC 142002-001	1 PC	Diathermy Bag	30x35
		• Adhesive	
CR 143013-000	1 PC	Mayo Stand Cover Reinforced	80x80
41015-0000	1 PC	Impervious Split Sheet	160x180
		• 10x52 Cm Split	
		• Adhesive	
CR 143079-000	1 PC	Stockinette	L 20x20
CR 143123-000	1 PC	Suction Tubing 10" Feet	
30104-0000	1 PC	Arthroscopy Drape with Fluid Collection Pouch	270x320
		• Fluid Collection Pouch	
		• Absorbent Laminated Reinforcement	
		• Tube Holder	
CR 142043-000	3 PCS	ISO Seal Drape Tape Strips	10x45
CP 141066-000	1 PC	Carry Bag	



## Vertical Isolation Pack : Product Code - #66722-0000

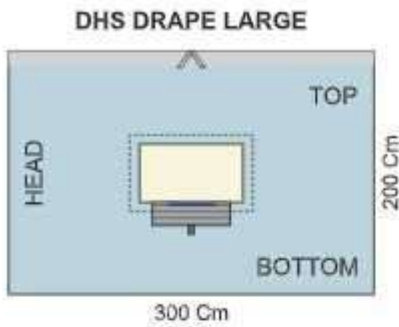

Item Code	Qty.	Contents	Size(cm)
318-160-200S	1 PC	Back Table Cover Reinforced	160x200
CR 143027-038	4 PCS	Surgical Gown Wrap Around	L
CR 143029-000	4PCS	Hand Towel	30x30
30241-0000	1 PC	DHS Drape with Fluid Collection Pouch <ul style="list-style-type: none"> <li>• 62x25 Cm Fenestration</li> <li>• Incise</li> <li>• Fluid Collection Bag</li> <li>• Adhesive</li> </ul>	300x200
CR 143041-012	5 PCS	Mopping Pad	30x30
CC 142002-200	1 PC	Cautery Bag	28x20
CR 143005-000	2 PCS	Apron	XL
CR 143010-002	1 PC	Camera Cover <ul style="list-style-type: none"> <li>• Card Board Support</li> <li>• Adhesive with Release</li> </ul>	240x20
318-160-200S	1 PC	Trolley Sheet	160x200
CP 141066-000	1 PC	Carry Bag	

## Spinal Pack : Product Code - #66709-0000

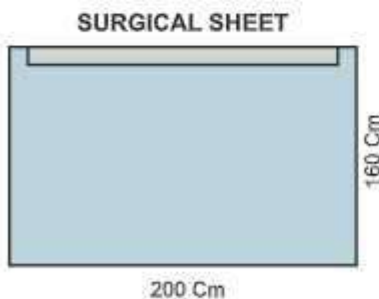
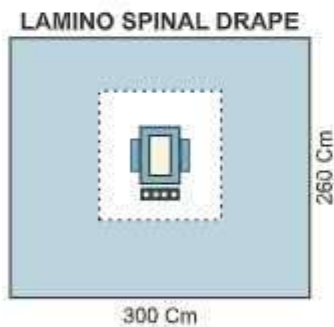

Item Code	Qty.	Contents	Size(cm)
085-160-125S	1 PC	Back Table Cover Reinforced	160x125
CR 143027-009	3 PCS	Cardiac Gown	L
CR 143029-000	4 PCS	Hand Towel	30x30
CR 143083-006	1 PC	Trolley Sheet Plastic Blue	135x150
043-080-080A	4 PCS	Surgical Sheet with Adhesive <ul style="list-style-type: none"> <li>• Adhesive</li> </ul>	80x80
043-160-200A	2 PCS	Surgical Sheet with Adhesive <ul style="list-style-type: none"> <li>• Adhesive</li> </ul>	160x200
043-160-300S	1 PC	Surgical Sheet	160x300
30251-0000	1 PC	Lamino Spinal Drape <ul style="list-style-type: none"> <li>• Absorbent Laminated Reinforcement</li> <li>• Tube Holder</li> <li>• Pockets</li> <li>• Hygiene Sheet</li> <li>• Incise</li> <li>• 25x15 Cm Fenestration</li> </ul>	260x300
CP 141066-000	1 PC	Carry Bag	





## Universal Extremity Pack : Product Code - #66724-0000

### UNIVERSAL EXTREMITY DRAPE

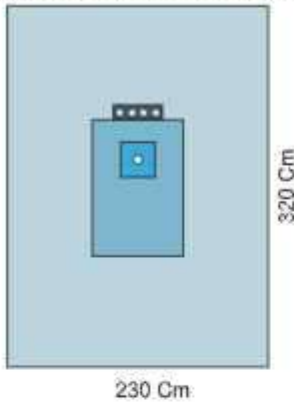

### LEG-U-DRAPE

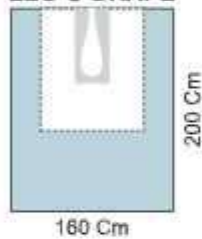

Item Code	Qty.	Contents	Size(cm)
318-160-200S	1 PC	Back Table Cover Reinforced	160x200
CR 143027-038	3 PCS	Surgical Gown Wrap Around	L
CR 143029-000	3 PCS	Hand Towel	30x30
CR 143027-009	1 PC	Cardiac Gown	L
CR 143029-000	1 PC	Hand Towel	30x30
CR 143041-012	10 PCS	Mopping Pad	30x30
318-160-200S	1 PC	Trolley Sheet	160x200
30271-0000	1 PC	LEG U* Drape	160x200
		<ul style="list-style-type: none"> <li>• Adhesive</li> <li>• Hygiene Sheet</li> <li>• 17x73 Cm Split</li> </ul>	
44004-0000	1 PC	Universal Extremity Drape	230x320
		<ul style="list-style-type: none"> <li>• Absorbent Laminated Reinforcement</li> <li>• Tube Holder</li> </ul>	
CR 143079-000	1 PC	Stockinette	L 10x200
CP 141066-000	1 PC	Carry Bag	

## TKR Pack I : Product Code - #66706-0001

### LEG-U-DRAPE

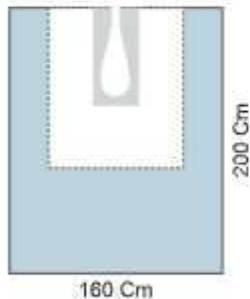

### SURGICAL SHEET

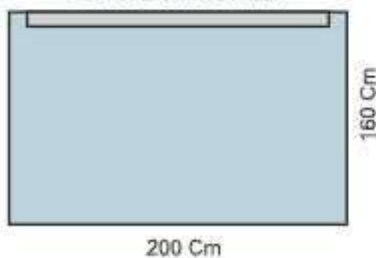

Item Code	Qty.	Contents	Size(cm)
085-160-230S	1 PC	Back Table Cover Reinforced	160x230
CR 143027-038	6 PCS	Surgical Gown Wrap Around	L
CR 143029-000	6 PCS	Hand Towel	30x30
085-160-230S	1 PC	Trolley Sheet Laminated Reinforced	160x230
043-160-260A	4 PCS	Screen Sheet	160x260
		<ul style="list-style-type: none"> <li>• Adhesive</li> </ul>	
043-160-200A	3 PCS	Surgical Sheet	160x200
		<ul style="list-style-type: none"> <li>• Adhesive</li> </ul>	
043-130-100A	5 PCS	Surgical Sheet	130x100
		<ul style="list-style-type: none"> <li>• Adhesive</li> </ul>	
30271-0000	1 PC	LEG U* Drape	160x200
		<ul style="list-style-type: none"> <li>• Adhesive</li> <li>• Hygiene Sheet</li> <li>• 17x73 Cm Split</li> </ul>	120x100
CP 141066-000	1 PC	Carry Bag	



**TKR Pack II : Product Code - #66706-0002**

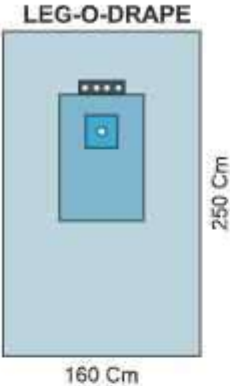

Item Code	Qty.	Contents	Size(cm)
085-160-230S	1 PC	Back Table Cover Reinforced	160x230
043-080-100S	2 PCS	Surgical Sheet	100x80
043-100-250S	4 PCS	Surgical Sheet	100x250
043-160-150S	3 PCS	Surgical Sheet	160x150
44002-0000	1 PC	LEG O" Drape	150x160
		<ul style="list-style-type: none"> <li>Absorbent Laminated Reinforcement</li> <li>Tube Holder</li> </ul>	
085-160-230S	1 PC	Trolley Sheet Laminated Reinforcement	160x230
CP 141066-000	1 PC	Carry Bag	

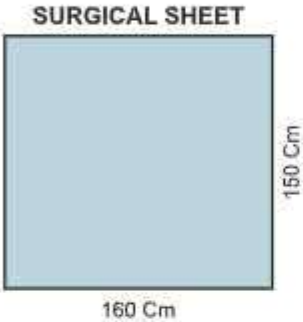



## Bilateral Knee Pack : Product Code - #66701-0000

### BILATERAL KNEE-O-DRAPE

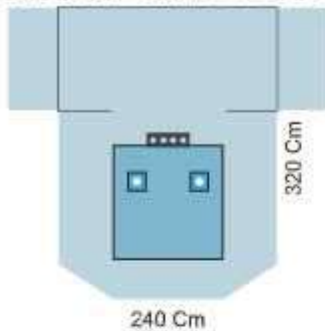

### LEG-U-DRAPE

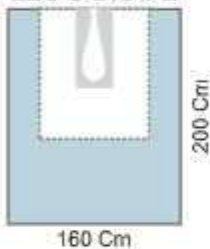

Item Code	Qty.	Contents	Size(cm)
318-160-200S	1 PC	Back Table Cover Reinforced	160x200
CR 143027-009	1 PC	Cardiac Gown	L
CR 143029-030	1 PC	Hand Towel	30x30
CR 143027-038	3 PCS	Surgical Gown Wrap Around	L
CR 143027-000	3 PCS	Hand Towel	30x30
043-160-200A	2 PCS	Surgical Sheet with Adhesive	160x200
		• Adhesive	
043-080-100A	2 PCS	Surgical Sheet with Adhesive	100x80
		• Adhesive	
CR 143041-012	15 PCS	Mopping Pad	30x30
3036-0000	1 PC	Bilateral Knee O <sup>o</sup> Drape	320x240
		• Absorbent Laminated Reinforcement	
		• Tube Holder	
		• Arm Board Covers	
30271-0000	2 PCS	LEG U <sup>o</sup> Drape	160x200
		• Adhesive	
		• Hygiene Sheet	120x100
		• 17x73 Cm Split	
318-160-200S	1 PC	Trolley Sheet	160x200
CP 141066-000	1 PC	Carry Bag	

## Hand Pack : Product Code - #66511-0000

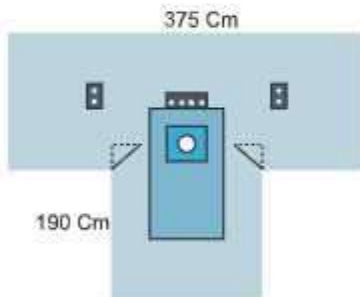

### IMPERVIOUS SPLIT SHEET

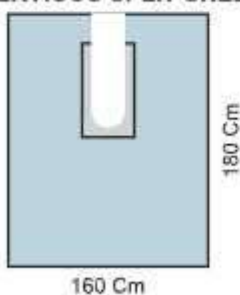

Item Code	Qty.	Contents	Size(cm)
085-160-125S	1 PC	Back Table Cover Reinforced	160x125
CR 143027-027	1 PC	Surgical Gown Overlap	XL
CR 143029-000	2 PCS	Hand Towels	30x30
CR 143039-000	1 PC	Mayo Stand Cover Reinforced	80x80
043-060-040A	2 PCS	Utility Drape	60x40
		• Adhesive	
CC 142002-001	1 PC	Diathermy Bag	30x35
		• Adhesive	
043-160-200S	1 PC	Surgical Sheet	160x200
41015-0000	1 PC	Impervious Split Sheet	160x80
		• 10x52 Cm Split	
		• Adhesive	
CR 143079-000	1 PC	Stockinette	L 10x200
CR 143041-012	6 PCS	Mopping Pad	30x30
44012-0000	1 PC	Hand Drape with Arm Board Covers	375x190
		• Absorbent Laminated Reinforcement	
		• Tube Holder	
		• Arm Board Covers	
CP 141066-000	1 PC	Carry Bag	



## Shoulder Arthroscopy Pack I : Product Code - #66121-0001

### SHOULDER ARTHROSCOPY DRAPE

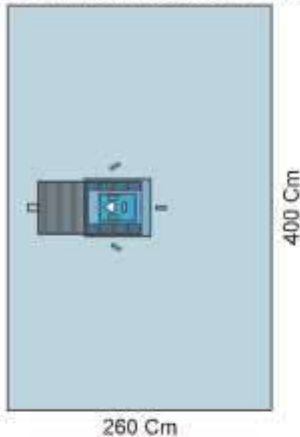

### MAYO STAND COVER

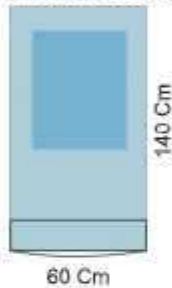

Item Code	Qty.	Contents	Size(cm)
085-160-100S	1 PC	Back Table Cover Reinforced	160x100
CR 143027-009	3 PCS	Cardiac Gown	L
CR 143029-000	3 PCS	Hand Towels	30x30
085-350-075S	1 PC	Trolley Sheet with Absorbent Laminated Reinforcement	350x75
CR 143039-004	1 PC	• Absorbent Laminated Reinforcement	100x75
3021-0000	1 PC	Mayo Stand Cover Reinforced	140x60
		Shoulder Arthroscopy Drape	400x260
		• Absorbent Laminated Reinforcement	
		• Fluid Collection Pouch with Pocket	
CP 141066-000	1 PC	Carry Bag	

## Shoulder Arthroscopy Lateral Pack II : Product Code - #66121-0002

### SHOULDER ARTHROSCOPY LATERAL

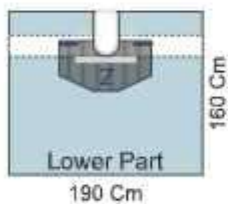
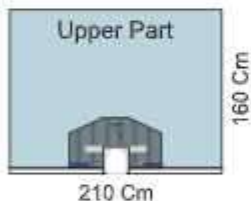

### CAMERA COVER



Item Code	Qty.	Contents	Size(cm)
318-160-200S	1 PC	Back Table Cover Reinforced	160x200
CR 143027-038	5 PCS	Surgical Gown Wrap Around	L
CR 143029-000	5 PCS	Hand Towel	30x30
30151-0000	1 PC	Shoulder Arthroscopy Drape Lateral	210x160
		• 28x15 Split	
		• 20x15 Split	
		• Fluid Collection Pouch	
		• Adhesive	
		• Absorbent Laminated Reinforcement	
CR 143005-000	2 PCS	Apron	XL
CR 143010-002	3 PCS	Camera Cover	240x20
		• Card Board Support	
		• Adhesive with Release	
CP 141066-000	1 PC	Carry Bag	



# HyCare

BABY DIAPERS



## General Surgical Products

extra soft... super absorbent...

- Sterile Surgical Disposables
- Hygiene Products
- General Surgical Products





## STERILE SURGICAL DISPOSABLES



**CARED RIP**  
IV SET  
IV SET VENTED  
IV SET WITH NON RETURN MEMBRANE



**HEMOCARE**  
BLOOD TRANSFUSION SET



**ENDOTRACHEAL TUBE**  
CUFFED, NON CUFFED



**LAP SPONGE  
MOPPING PAD**  
12 Ply with and without X Ray  
Detection thread  
5 x 5 cm, 7.5 x 7.5 cm, 10 x 10 cm



**GUAZE SWAB**  
12 Ply with and without X Ray  
Detection thread  
5 x 5 cm, 7.5 x 7.5 cm, 10 x 10 cm



**CANNULA FIXATOR  
CAREFIX**



**IV CANNULA**



**URINE DRAINAGE  
BAG**  
CAREFLOW Deluxee<sup>®</sup>  
Uro.C  
Careflow Uro Meter



HYGIENE PRODUCTS



**STERILE PAD**

Sizes 60 x 90 cm, 60 x 60, 40 x 40



**ADULT DIAPER**



**NEW BORN  
BABY DIAPER**



**HAND TOWEL**



**BABY WIPER**



**NURSE'S CAP**

Nose Mask  
Nurses Cap  
Surgeon's Cap  
Face Mask 2 Play, 3 Play  
face Mask with Fog free  
with eye Shield

**GENERAL SURGICAL PRODUCTS**



**SURGICAL CLIPPER**



**NEBULIZER**



**ANAESTHESIA MASK  
ADULT / PEDIATRIC**



**CORD CLAMP**



**GOGGLES**



**ID BAND**



*Maintaining the Thread of Life*

**Factory : Careon Healthcare Solutions Pvt. Ltd.**

Kinfra Hi-Tech Bio Technology Park  
Kalamassery, Cochin - 683503

+91 - 75599 00009, +91 - 75588 00008

info@careonhealthcare.com www.careonhealthcare.com

Toll free No : 1800 - 123 - 1575