

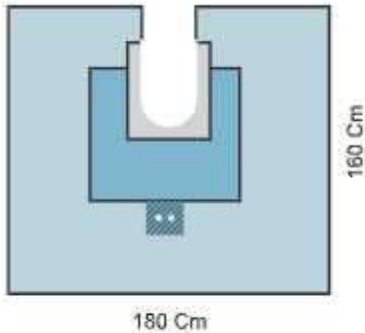

Ophthalmic & ENT Packs & Drapes

- **Single Drapes**
- **Dental Packs**
- **Thyroid Packs**
- **Eye Packs**
- **ENT Packs**

EYE DRAPE



Product Code #	Description	Size(cm)
30213-0000	Eye Drape <ul style="list-style-type: none"> • Adhesive • Absorbent Laminated Reinforcement • 8x58 Cm Split • Tube holder 	160x180

THYROID DRAPE

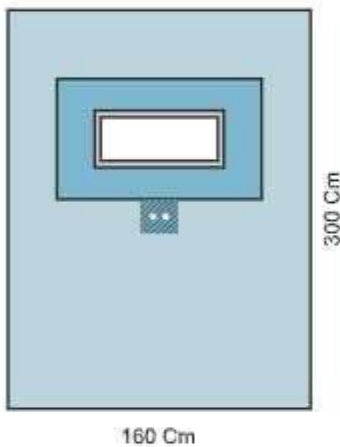

Product Code #	Description	Size(cm)
30312-0000	Thyroid Drape <ul style="list-style-type: none"> • Adhesive • Absorbent Laminated Reinforcement • 8x20 Cm fenestration • Tube Holder 	160x300

DENTAL DRAPE

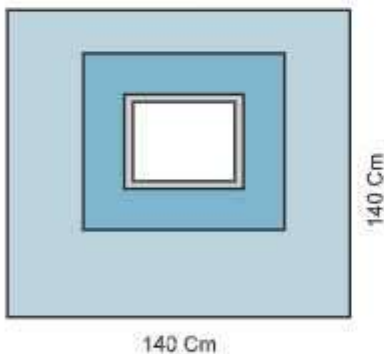

Product Code #	Description	Size(cm)
40101-0000	Dental Drape <ul style="list-style-type: none"> • Adhesive • Absorbent Laminated Reinforcement • 12x12 Cm Fenestration 	140x140

FENESTRATED DRAPE

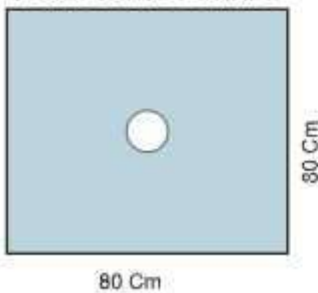

Product Code #	Description	Size(cm)
043-080-080S	Fenestrated Drape <ul style="list-style-type: none"> • 8 Cm Circular Fenestration 	80x80



OPHTHALMIC DRAPE

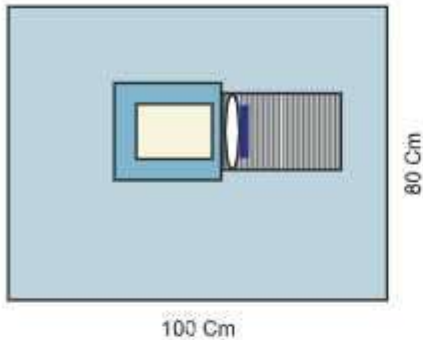

Product Code #	Description	Size(cm)
30281-0000	Ophthalmic Drape <ul style="list-style-type: none"> • Absorbent Laminated reinforcement • 9x4 Cm Fenestration • Incise • Fluid Collection Pouch • Light weight fabric 	100x80

OPHTHALMIC DRAPE

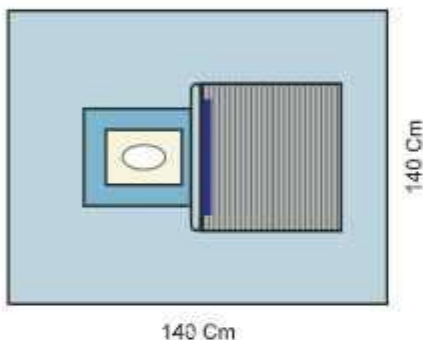

Product Code #	Description	Size(cm)
30283-0000	Ophthalmic Drape <ul style="list-style-type: none"> • 5x7 Cm Oval Fenestration • Light Weight Fabric • Incise • Absorbent Laminated Reinforcement • Fluid Collection Pouch 	140x140

HEAD DRAPE WITH TURBAN

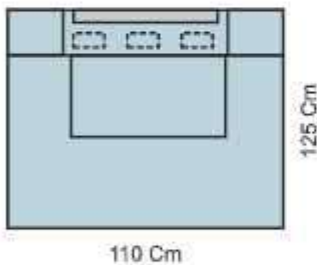

Product Code #	Description	Size(cm)
32101-0000	Head Drape with Turban <ul style="list-style-type: none"> • Adhesive • Turban 50x80 Cm 	125x110

HEAD DRAPE WITH ABSORBENT REINFORCEMENT

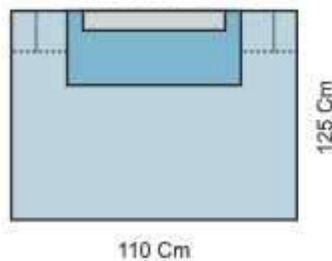

Product Code #	Description	Size(cm)
32102-0000	Head Drape with Absorbent Reinforcement <ul style="list-style-type: none"> • Adhesive • Absorbent laminated reinforcement 	110x125



ENT SPLIT DRAPE

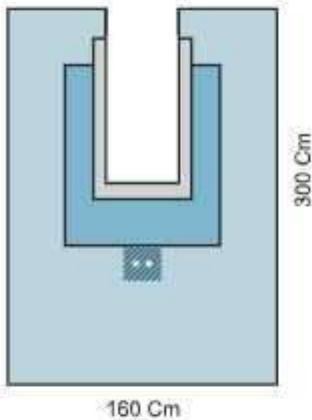

Product Code #	Description	Size(cm)
30214-0000	ENT Split Drape <ul style="list-style-type: none"> • Adhesive • 7x57 Cm Split • Absorbent Laminated Reinforcement • Tube holder 	300x160

OPHTHALMIC DRAPE

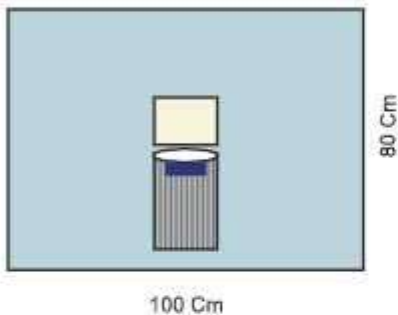

Product Code #	Description	Size(cm)
30282-0000	Ophthalmic Drape <ul style="list-style-type: none"> • Incise 9x6.5 Cm Fenestration • Fluid Collection Pouch • Light Weight Fabric 	80x100

OPHTHALMIC DRAPE

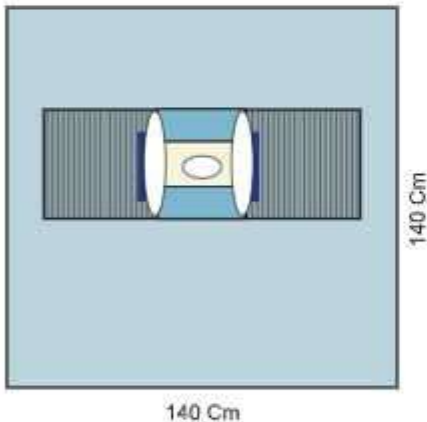

Product Code #	Description	Size(cm)
30284-0000	Ophthalmic Drape <ul style="list-style-type: none"> • Light Weight Fabric • 5x7 Cm Oval Fenestration • Dual Fluid Collection Pouch • Absorbent Laminated Reinforcement • Incise 	140x140

EYE DRAPE

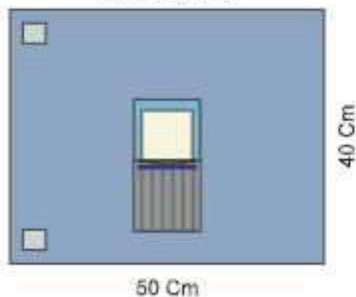

Product Code #	Description	Size(cm)
30211-0000	Eye Drape <ul style="list-style-type: none"> • MII Poly Plastic Blue • Absorbent Laminated reinforcement • Adhesive • Incise • Fluid Collection Pouch • 9x4 fenestration 	40x50



Dental Pack : Product Code - #66804 - 0000

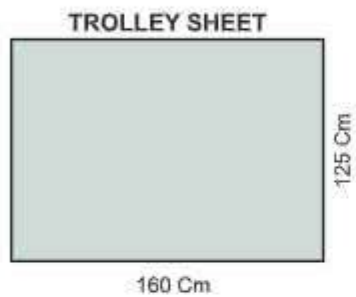
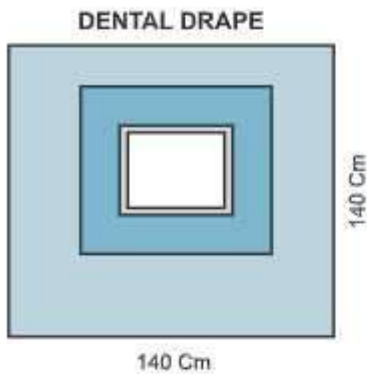

Item Code	Qty.	Contents	Size(cm)
085-160-100S	1 PC	Back Table Cover Reinforced	160x100
CR 143027-024	2 PCS	Surgical Gown	L
CR 143029-000	2 PCS	Hand Towel	30x30
CR 143041-012	6 PCS	Mopping Pad	30x30
40101-0000	1 PC	Dental Drape	
		<ul style="list-style-type: none"> • Adhesive • Absorbent Laminated Reinforcement • 12x12 Square Fenestration 	
085-160-125S	1 PC	Trolley Sheet	160x125
CP 141066-00	1 PC	Carry Bag	



Thyroid Pack : Product Code - #66602-0000

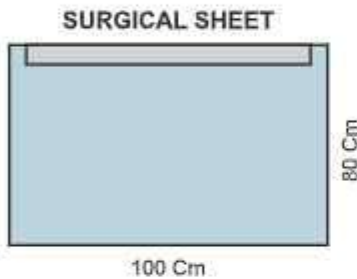
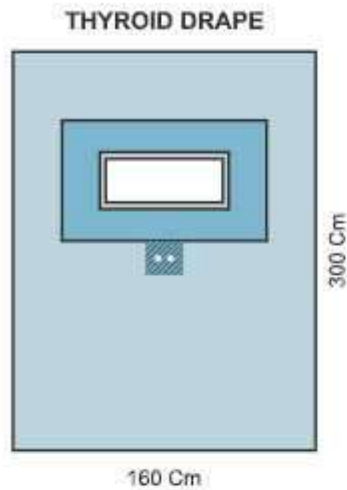

Item Code	Qty.	Contents	Size(cm)
085-160-100S	1 PC	Back Table Cover Reinforced	160x100
CR 143027-030	2 PCS	Surgical Gown Reinforced	L
CR 143029-000	2 PCS	Hand Towel	30x30
CR 143041-012	6 PCS	Mopping Pad	30x30
043-080-100A	2 PCS	Surgical Drape with Adhesive	100x80
		• Adhesive	
085-160-125S	1 PC	Trolley Sheet	160x125
30312-0000	1 PC	Thyroid Drape	160x300
		• Adhesive	
		• Absorbent Laminated Reinforcement	
		• 8x20 Cm Fenestration	
		• Tube Holder	
CP 141066	1 PC	Carry Bag	



Eye Pack I : Product Code - #66601-0001

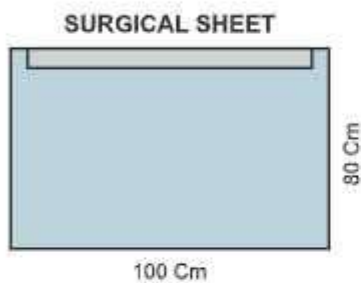
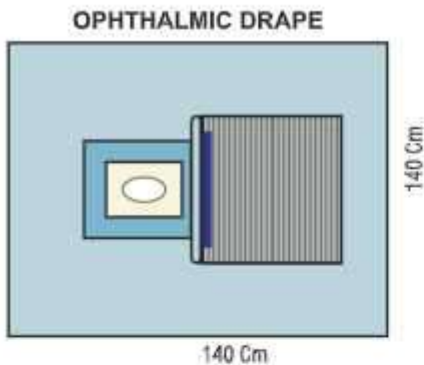

Item Code	Qty.	Contents	Size(cm)
085-160-100S	1 PC	Back Table Cover Reinforced	160x100
CR 143027-024	2 PCS	Surgical Gown	
CR 143029-000	2 PCS	Hand Towel	30x30
CC 149042-000	1 PC	Eye Pad	
CR 143024-002	10 PCS	Gauze Swab X-Ray Detectable	10x10
30283-0000	1 PC	Ophthalmic Drape with Fluid Collection Pouch	140x140
		<ul style="list-style-type: none"> • 5x7 Cm Oval Fenestration • Light Weight Fabric • Incise • Absorbent Laminated Reinforcement • Fluid Collection Pouch 	
030-160-125S	1 PC	Trolley Sheet	160x125
043-080-100A	2 PCS	Surgical Sheet	100x80
CP 141066-000	1 PC	*Adhesive Carry Bag	

Eye Pack II : Product Code - #66601-0002

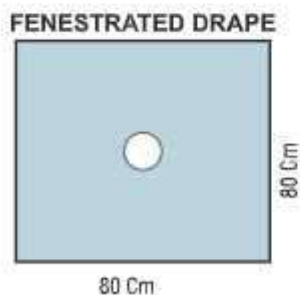
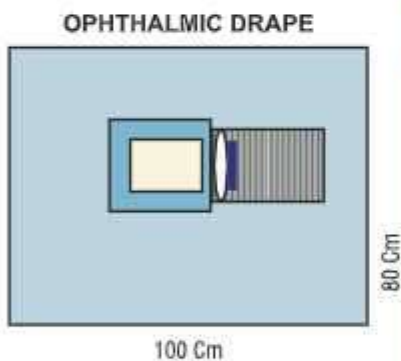

Item Code	Qty.	Contents	Size(cm)
085-160-125S	1 PC	Back Table Cover Reinforced	160x125
043-160-100S	1 PC	Surgical Sheet	160x100
30281-0000	1 PC	Eye Drape	100x80
		<ul style="list-style-type: none"> • Incise • Fluid Collection Pouch • 9x4 Cm Fenestration 	
043-080-080S	1 PC	Fenestrated Drape	80x80
		<ul style="list-style-type: none"> • 8 Cm Circular Fenestration 	
043-080-100A	2 PCS	Surgical Sheet with Adhesive	100x80
		<ul style="list-style-type: none"> • Adhesive 	
030-160-125S	1 PC	Trolley Sheet	160x125
CP 141066-000	1 PC	Carry Bag	



Eye Pack III : Product Code - #66601-0003

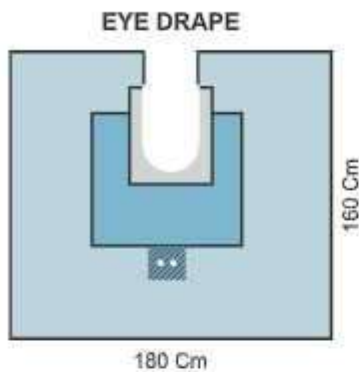

HEAD DRAPE WITH ABSORBENT REINFORCEMENT

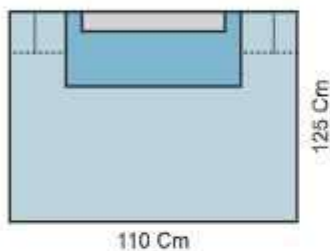

Item Code	Qty.	Contents	Size(cm)
085-160-100S	1 PC	Back Table Cover Reinforced	160x100
CR 143027-024	1 PC	Surgical Gown	L
CR 143029-000	2 PCS	Hand Towel	30x30
CR 143029-000	4 PCS	Hand Towel	30x30
CC 149042-000	1 PC	Eye Pad	
CR 143024-002	10 PCS	Gauze Swab X-Ray Detectable	10x10
32102-0000	1 PC	Head Drape	110x95
		• Adhesive	
		• Absorbent Laminated Reinforcement	
30213-0000	1 PC	Eye Drape	160x180
		• Adhesive	
		• Absorbent Laminated Reinforcement	
		• Tube Holder	
030-160-125S	1 PC	Trolley Sheet	160x125
CP 141066-000	1 PC	Carry Bag	

ENT Pack I : Product Code - #66601-0000

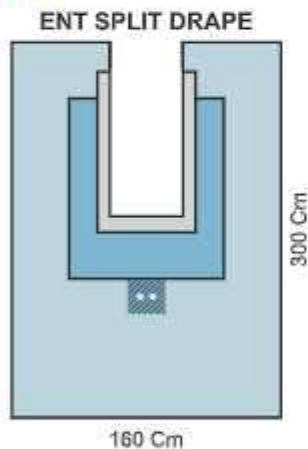

HEAD DRAPE WITH TURBAN

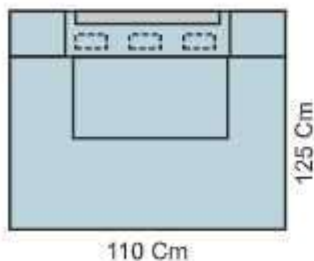

Item Code	Qty.	Contents	Size(cm)
085-160-100S	1 PC	Back Table Cover Reinforced	160x100
CR 143027-024	1 PC	Surgical Gown	L
CR 143029-000	1 PC	Hand Towel	30x30
CR 143039-000	1 PC	Mayo Stand Cover Reinforced	80x80
043-060-040A	2 PCS	Utility Drape	60x40
		• Adhesive	
CC 142002-001	1 PC	Diathermy Bag	30x35
		• Adhesive	
CR 143029-000	2 PCS	Hand Towel	30x30
32101-0000	1 PC	Head Drape with Turban	125x110
		• Adhesive	
		• Turban 50x80 Cm	
30214-0000	1 PC	EENT Drape	160x130
		• Adhesive	
		• Absorbent Laminated Reinforcement	
		• Tube Holder	
		• 7x57 Cm Split	
030-160-125S	1 PC	Trolley Sheet	160x125
CP 141066-000	1 PC	Carry Bag	

