

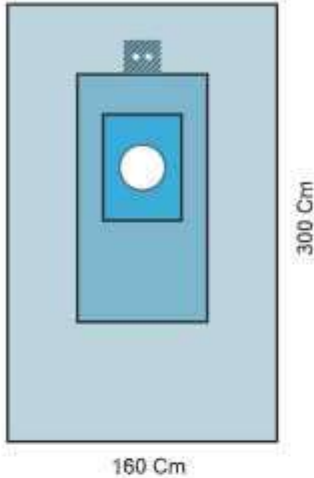

Orthopedic Packs & Drapes

- **Single Drapes**
- **Ortho Packs**
- **HIP Packs**
- **Arthroscopy Packs**
- **Vertical Isolation Packs**
- **Spinal Packs**
- **Knee Packs**

UPPER EXTREMELY DRAPE



Product Code #	Description	Size(cm)
44001-0000	Upper Extremity Drape <ul style="list-style-type: none"> • Absorbent Laminated Reinforcement • Tube Holder 	160x300

EXTREMITY PREP PAD

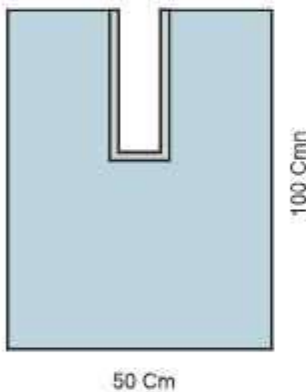

Product Code #	Description	Size(cm)
41016-0000	Extremity Prep Pad <ul style="list-style-type: none"> • Absorbent Laminated Reinforcement • Adhesive • 10x32 Cm Split 	100x50

IMPERVIOUS SPLIT SHEET

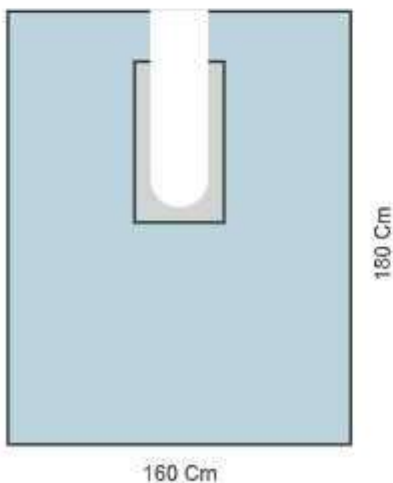

Product Code #	Description	Size(cm)
41015-0000	Impervious Split Sheet <ul style="list-style-type: none"> • Adhesive • 10x53 Cm Split 	160x180



BILATERAL KNEE-O-DRAPE

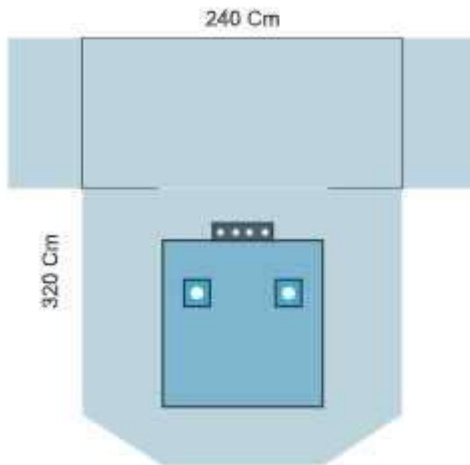

Product Code #	Description	Size(cm)
30306-0000	Bilateral Knee-O-Drape <ul style="list-style-type: none"> • Absorbent Laminated reinforcement • Tube holder 	240x320

HIP DRAPE WITH FLUID COLLECTION POUCH

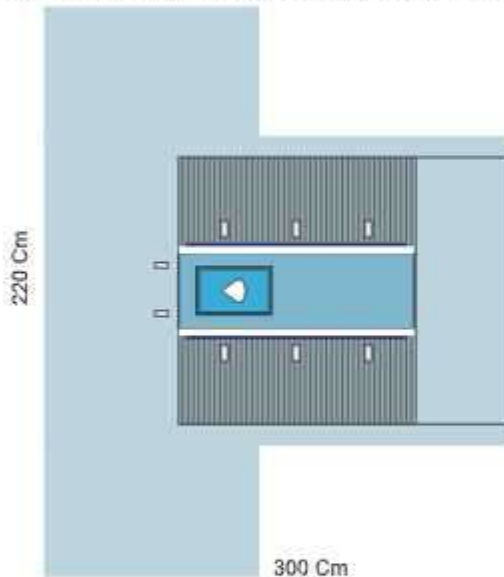

Product Code #	Description	Size(cm)
30291-0000	Hip Drape with Fluid Collection Pouch <ul style="list-style-type: none"> • Absorbent Laminated reinforcement • Tube holder • Velcro 	220x300

DHS DRAPE LARGE

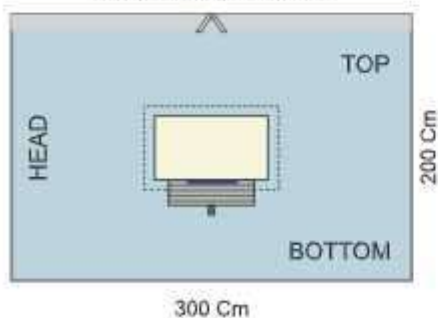

Product Code #	Description	Size(cm)
30241-0000	DHS Drape Large <ul style="list-style-type: none"> • Transparent Plastic • Incise • Fluid Collection Pouch • Adhesive • 30x70 fenestration 	200x300



ARTHROSCOPY DRAPE

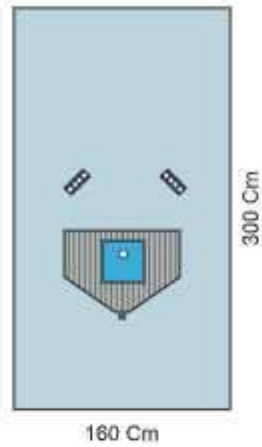

Product Code #	Description	Size(cm)
30101-0000	Arthroscopy Drape <ul style="list-style-type: none"> • Fluid Collection Pouch • Tube holder 	160x300

KNEE ARTHROSCOPY

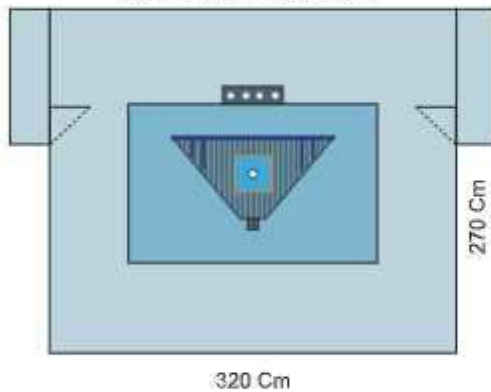

Product Code #	Description	Size(cm)
30104-0000	Knee Arthroscopy <ul style="list-style-type: none"> • Absorbent Laminated Reinforcement • Tube holder • Fluid Collection Pouch 	320x270

HIP-U-DRAPE

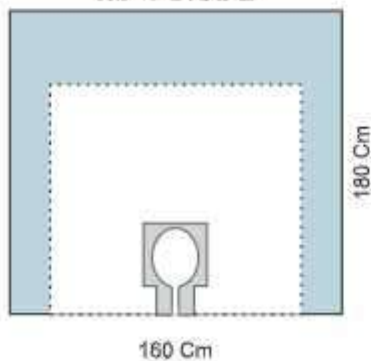

Product Code #	Description	Size(cm)
30292-0000	Hip-U-Drape <ul style="list-style-type: none"> • Hygiene Sheet • Adhesive 	180x160



LAMINO SPINAL DRAPE

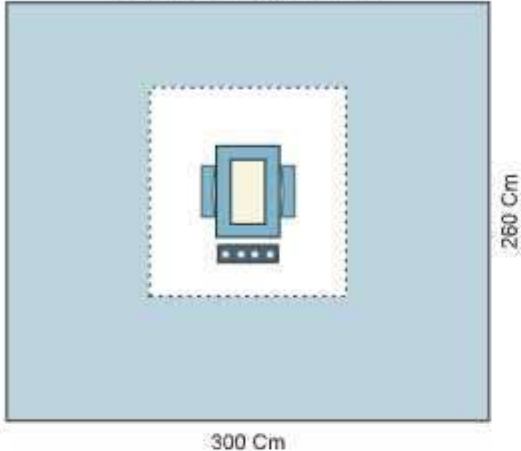

Product Code #	Description	Size(cm)
30251-0001	Lamino Spinal Drape <ul style="list-style-type: none"> • Absorbent Laminated reinforcement • Hygiene Sheet • Tube holder • Incise 	300x260

SPLIT U DRAPE

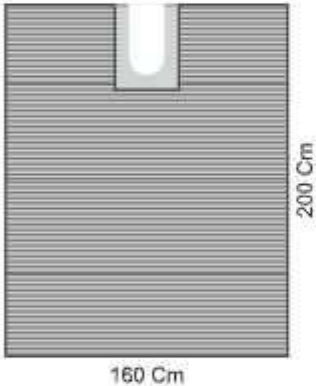

Product Code #	Description	Size(cm)
30331-0000	Split-U-Drape <ul style="list-style-type: none"> • Transparent Plastic • Adhesive 	200x160



ORTHO U DRAPE

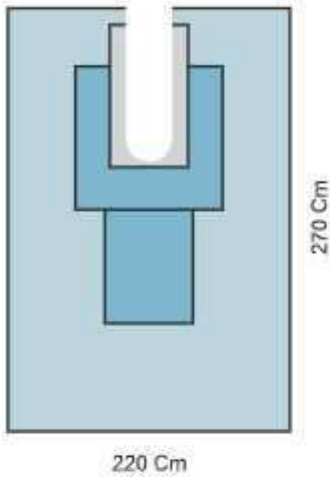

Product Code #	Description	Size(cm)
41014-0000	Ortho U Drape <ul style="list-style-type: none"> • 10x100 Cm Split • Absorbent Laminated Reinforcement • Adhesive 	270x220

BAR DRAPE

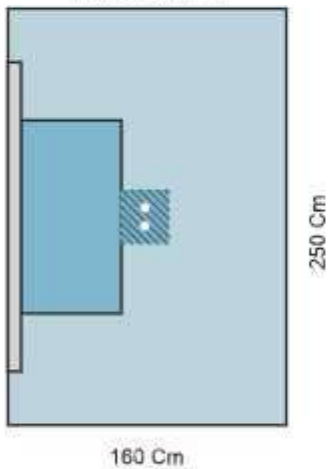

Product Code #	Description	Size(cm)
41013-0000	Bar Drape <ul style="list-style-type: none"> • Absorbent Laminated Reinforcement • Tube Holder • Adhesive 	160x250



SHOULDER ARTHROSCOPY DRAPE

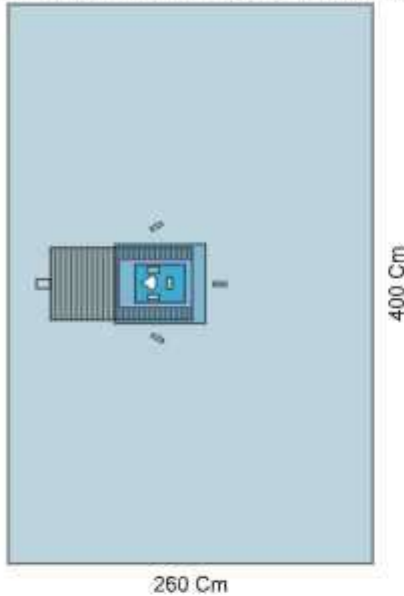

Product Code #	Description	Size(cm)
30121-0000	Shoulder Arthroscopy Drape <ul style="list-style-type: none"> • Absorbent Laminated reinforcement • Adhesive • Fluid Collection Pouch • Velcro 	260x400

SHOULDER ARTHROSCOPY LATERAL

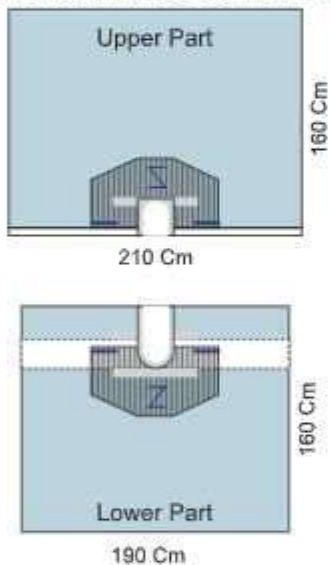

Product Code #	Description	Size(cm)
30151-0000	Shoulder Arthroscopy Lateral <ul style="list-style-type: none"> • Absorbent fabric • Adhesive • Fluid Collection Pouch • Velcro 	210x160

Product Code #	Description	Size(cm)
30151-0000	Shoulder Arthroscopy Lateral <ul style="list-style-type: none"> • Absorbent fabric • Adhesive • Fluid Collection Pouch • Velcro 	160x190

UNIVERSAL EXTREMITY DRAPE

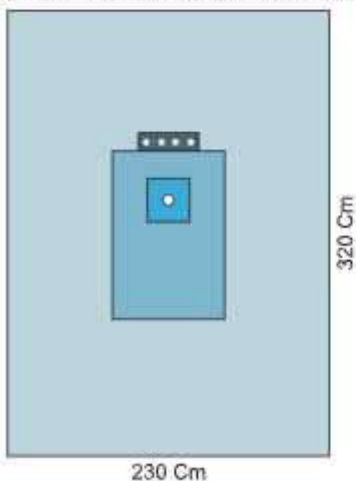

Product Code #	Description	Size(cm)
44004-0000	Universal Extremity Drape <ul style="list-style-type: none"> • Absorbent Laminated reinforcement • Tube holder 	230x320



LEG-O-DRAPE

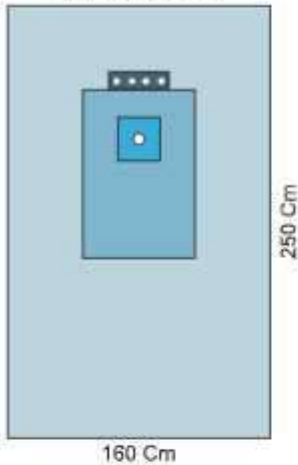

Product Code #	Description	Size(cm)
44002-0000	Leg-O-Drape <ul style="list-style-type: none"> • Absorbent Laminated reinforcement • Tube holder 	160x250

LEG-U-DRAPE

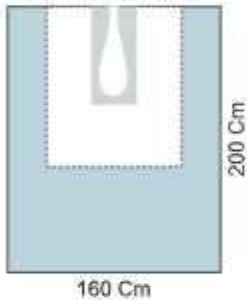

Product Code #	Description	Size(cm)
30271-0000	Leg-U-Drape <ul style="list-style-type: none"> • Hygiene Sheet • Adhesive 	160x200

KNEE-O-PREMIUM

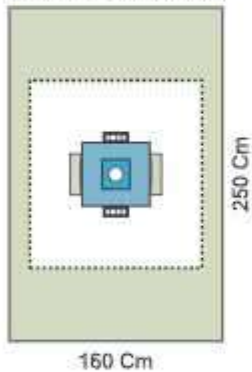

Product Code #	Description	Size(cm)
30301-0000	Knee-O-Drape Premium <ul style="list-style-type: none"> • Absorbent Laminated reinforcement • Hygiene Sheet • Tube Holder • Pockets 	160x250

HAND DRAPE WITH ARM BOARD COVERS

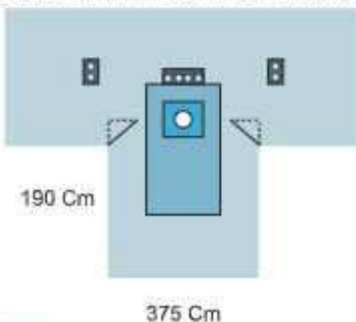

Product Code #	Description	Size(cm)
44012-0000	Hand Drape with Arm Board Covers <ul style="list-style-type: none"> • Absorbent Laminated reinforcement • Tube Holder • Arm Board Covers 	375x190



Ortho Pack I : Product Code - #66361-0001

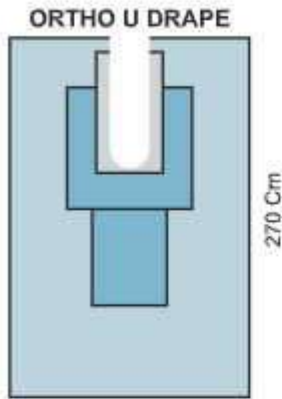

220 Cm

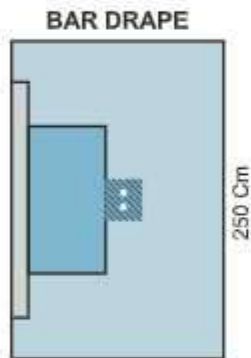

160 Cm

Item Code	Qty.	Contents	Size(cm)
318-160-200S	1 PC	Back Table Cover Reinforced	160x200
CR 143027-030	2 PCS	Surgical Gown Reinforced	L
CR 143029-000	2 PCS	Hand Towel	30x30
CR 143030-000	1 PC	Mayo Stand Cover Reinforced	80x80
043-040-060A	4 PCS	Utility Drape	60x40
		• Adhesive	
CC 142002-003	1 PC	Suture Bag	
41015-0000	1 PC	Impervious Split Sheet	160x180
		• 10x52 Cm Split	
		• Adhesive	
085-160-230S	1 PC	Trolley Sheet Laminated Reinforced	160x230
CR 143079-000	1 PC	Stockinette	L20x20
41014-0000	1 PC	Ortho U" Drape	270x220
		• 10x100 Cm Split	
		• Absorbent Laminated Reinforcement	
		• Adhesive	
41013-0000	1 PC	Ortho Bar Drape	160x250
		• Absorbent Laminated Reinforcement	
		• Tube Holder	
		• Adhesive	
CP 141066-000	1 PC	Carry Bag	

Ortho Pack II : Product Code - #66361-0002

UPPER EXTREMELY DRAPE

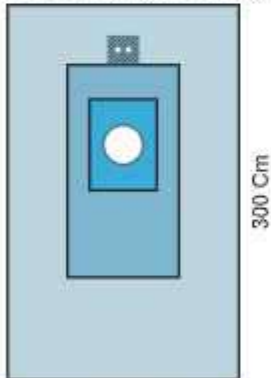

160 Cm

IMPERVIOUS SPLIT SHEET

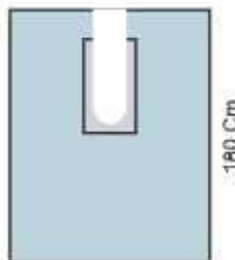

160 Cm

Item Code	Qty.	Contents	Size(cm)
085-160-125S	1 PC	Back Table Cover Reinforced	160x125
CR 143027-038	4 PCS	Surgical Gown Wrap Around	L
CR 143029-000	4 PCS	Hand Towel	30x30
318-160-200S	1 PC	Trolley Sheet	160x200
043-163-200A	2 PCS	Surgical Drape with Adhesive	160x200
		• Adhesive	
043-120-080A	3 PCS	Surgical Drape with Adhesive	120x80
		• Adhesive	
CR 143041-012	3 PCS	Mopping Pad	30x30
CR 143005-000	2 PCS	Apron	XL
41015-0000	1 PC	Impervious Split Sheet	160x180
44001-0000	1 PC	Upper Extremity Drape	160x300
		• Absorbent Laminated Reinforcement	
		• Tube Holder	
CR 143079-000	1 PC	Stockinette	L20x20
CR 142043-000	3 PCS	ISO Seal Drape Tape Strips	10x45
CP 141066-000	1 PC	Carry Bag	



Ortho Pack III : Product Code - #66361-0003

HIP-U-DRAPE

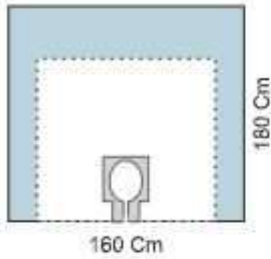

Surgical Sheet

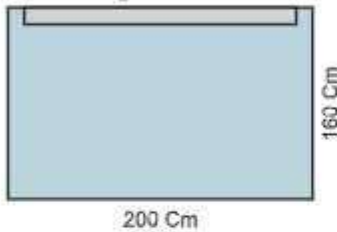

Item Code	Qty.	Contents	Size(cm)
085-160-125S	1 PC	Back Table Cover Reinforced	160x125
CR 143027-038	5 PCS	Surgical Gown Wrap Around	L
CR 143029-000	5 PCS	Hand Towel	30x30
043-160-200A	2 PCS	Surgical Drape	160x200
CR 143079-000	1 PC	Stockinette	L20x200
30292-0000	1 PC	HIP U* Drape	180x160
		<ul style="list-style-type: none"> • Hygiene Sheet • Adhesive • 30x24 Cm Oval Fenestration 	
CR 143041-012	3 PCS	Mopping Pad	30x30
CR 143005-000	2 PCS	Apron	XL
CR 143080-004	3 PCS	Surgical Cap	
CR 143024-000	3 PCS	Face Mast with Eye Shield	
CP 141066-000	1 PC	Carry Bag	

Ortho Pack IV : Product Code - #66361-0004

KNEE-O-PREMIUM

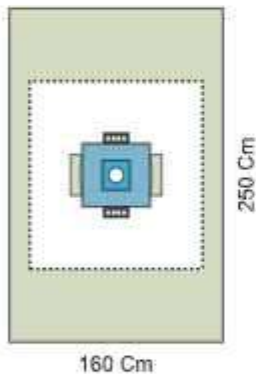

SURGICAL SHEET

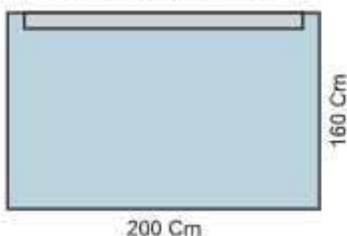

Item Code	Qty.	Contents	Size(cm)
085-160-125S	1 PC	Back Table Cover Reinforced	160x125
CR 143027-038	5 PCS	Surgical Gown Wrap Around	L
CR 143029-000	5 PCS	Hand Towel	30x30
043-160-200A	2 PCS	Surgical Drape	160x200
CR 143079-000	1 PC	Stockinette	L20x200
30301-0000	1 PC	Knee D* Drape	250x160
		<ul style="list-style-type: none"> • Hygiene Sheet • Tube Holder • Pockets 	
CR 143041-012	3 PCS	Mopping Pad	30x30
CR 143013-000	1 PC	Cling Drape	
CR 143005-000	2 PCS	Apron	XL
CR 143080-004	3 PCS	Surgical Cap	
CR 142024-000	3 PCS	Face Mast with Eye Shield	
CP 141066-000	1 PC	Carry Bag	



Arthroscopy Pack II : Product Code - #66101-0002

ARTHROSCOPY DRAPE

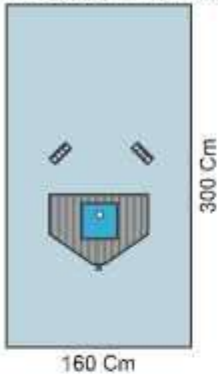

160 Cm

300 Cm

CLING DRAPE



APRON

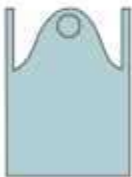

Item Code	Qty.	Contents	Size(cm)
085-160-200S	1 PC	Back Table Cover Reinforced	160x200
CR 143027-038	5 PCS	Surgical Gov'n Wrap Around	L
CR 143029-000	5 PCS	Hand Towel	30x30
30101-0000	1 PC	Arthroscopy Drape	160x300
		<ul style="list-style-type: none"> • Fluid Collection Pouch • Tube Holder 	
CR 143010-002	3 PCS	Camera Cover	240x20
		<ul style="list-style-type: none"> • Card Board Support • Adhesive with Release 	
CR 143013-000	1 PC	Cling Drape	
CR 143005-000	2 PCS	Apron	XL
CP 141066-000	1 PC	Carry Bag	

Arthroscopy Pack III : Product Code - #66101-0003

ARTHROSCOPY DRAPE

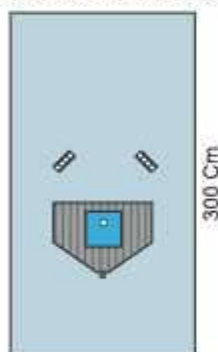

160 Cm

300 Cm

CAUTERY BAG

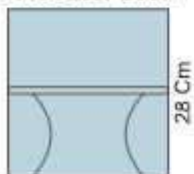

20 Cm

28 Cm

Item Code	Qty.	Contents	Size(cm)
085-080-100S	1 PC	Back Table Cover Reinforced	100x80
CR 143029-000	2 PCS	Hand Towel	30x30
CR 143013-000	1 PC	Cling Drape	
CR 143066-005	2 PCS	Shoe Cover	70x42
CR 143010-002	1 PC	Camera Cover	240x20
		<ul style="list-style-type: none"> • Card Board Support • Adhesive with Release 	
CC 142002-000	1 PC	Cautery Bag	28x20
30101-0000	1 PC	Arthroscopy Drape	160x300
		<ul style="list-style-type: none"> • Fluid Collection Pouch • Tube Holder 	
CP 141066-000	1 PC	Carry Bag	



HIP Pack : Product Code - #66051-0000

HIP DRAPE WITH FLUID COLLECTION POUCH

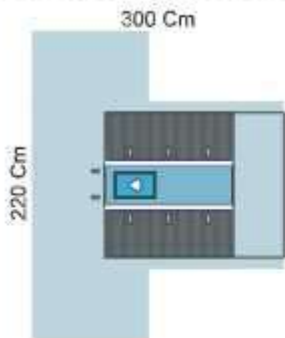

IMPERVIOUS SPLIT SHEET

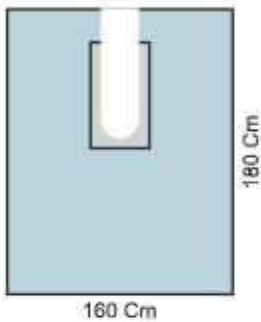

Item Code	Qty.	Contents	Size(cm)
318-160-180S	1 PC	Back Table Cover Reinforced	160x180
CR 143027-024	1 PC	Surgical Gown	L
CR 143029-000	1 PC	Hand Towel	30x30
CR 143027-030	2 PCS	Surgical Gown Reinforced	L
CR 143029-000	2 PCS	Hand Towels	30x30
CR 143029-000	1 PC	Mayo Stand Cover Reinforced	80x80
CC 142002-001	1 PC	Diathermy Bag	30x35
		• Adhesive	
CR 143079-000	1 PC	Stockinette	L 20x20
41015-0000	1 PC	Impervious Split Sheet	160x180
		• 10x25 Cm Split	
		• Adhesive	
043-160-200S	1 PC	Surgical Sheet	160x200
CR 143120-000	1 PC	Yankauer Tip	
CR 143123-000	1 PC	Suction Tubing 10" Feet	
CR 143005-000	1 PC	Apron	XL
CR 143013-000	1 PC	Cling Drape	
318-160-200S	1 PC	Trolley Sheet	160x200
30291-0000	1 PC	HIP Drape with Pockets	110x430
		• Fluid Collection Pouch	
		• Absorbent Laminated Reinforcement	
		• Arm Board Covers	
		• Tube Holder	
CP 141066-000	1 PC	Carry Bag	

Arthroscopy Pack I : Product Code - #66101-0001

KNEE ARTHROSCOPY

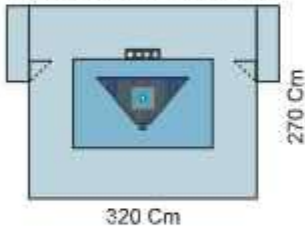

CAMERA COVER



EXTREMITY PREP PAD

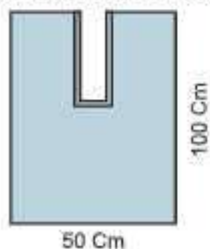

Item Code	Qty.	Contents	Size(cm)
318-160-200S	1 PC	Back Table Cover Reinforced	160x200
CR 143029-038	3 PCS	Surgical Gown Wrap Around	L
CR 143029-000	3 PCS	Hand Towel	30x30
CR 143027-030	2 PCS	Surgical Gown Reinforced	L
CR 143029-000	2 PCS	Hand Towels	30x30
41016-0000	1 PC	Extremity Prep Pad	100x50
		• Adhesive	
		• 10x32 Cm Split	
CR 143010-002	3 PCS	Camera Cover	240x20
		• Card Board Support	
		• Adhesive with Release	
CR 143013-000	1 PC	Cling Drape	
CR 143005-000	2 PCS	Apron	XL
CC 142002-001	1 PC	Diathermy Bag	30x35
		• Adhesive	
CR 143013-000	1 PC	Mayo Stand Cover Reinforced	80x80
41015-0000	1 PC	Impervious Split Sheet	160x180
		• 10x52 Cm Split	
		• Adhesive	
CR 143079-000	1 PC	Stockinette	L 20x20
CR 143123-000	1 PC	Suction Tubing 10" Feet	
30104-0000	1 PC	Arthroscopy Drape with Fluid Collection Pouch	270x320
		• Fluid Collection Pouch	
		• Absorbent Laminated Reinforcement	
		• Tube Holder	
CR 142043-000	3 PCS	ISO Seal Drape Tape Strips	10x45
CP 141066-000	1 PC	Carry Bag	



Vertical Isolation Pack : Product Code - #66722-0000

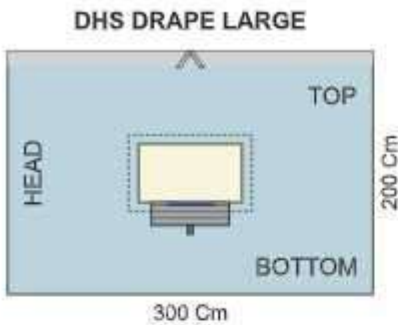

Item Code	Qty.	Contents	Size(cm)
318-160-200S	1 PC	Back Table Cover Reinforced	160x200
CR 143027-038	4 PCS	Surgical Gown Wrap Around	L
CR 143029-000	4PCS	Hand Towel	30x30
30241-0000	1 PC	DHS Drape with Fluid Collection Pouch <ul style="list-style-type: none"> • 62x25 Cm Fenestration • Incise • Fluid Collection Bag • Adhesive 	300x200
CR 143041-012	5 PCS	Mopping Pad	30x30
CC 142002-200	1 PC	Cautery Bag	28x20
CR 143005-000	2 PCS	Apron	XL
CR 143010-002	1 PC	Camera Cover <ul style="list-style-type: none"> • Card Board Support • Adhesive with Release 	240x20
318-160-200S	1 PC	Trolley Sheet	160x200
CP 141066-000	1 PC	Carry Bag	

Spinal Pack : Product Code - #66709-0000

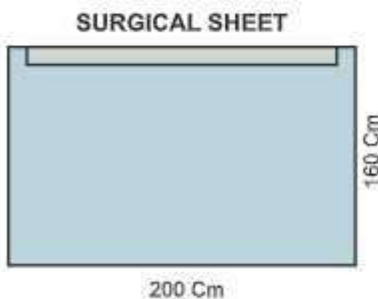
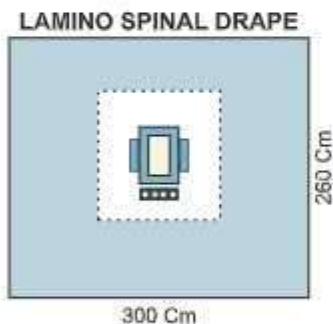

Item Code	Qty.	Contents	Size(cm)
085-160-125S	1 PC	Back Table Cover Reinforced	160x125
CR 143027-009	3 PCS	Cardiac Gown	L
CR 143029-000	4 PCS	Hand Towel	30x30
CR 143083-006	1 PC	Trolley Sheet Plastic Blue	135x150
043-080-080A	4 PCS	Surgical Sheet with Adhesive <ul style="list-style-type: none"> • Adhesive 	80x80
043-160-200A	2 PCS	Surgical Sheet with Adhesive <ul style="list-style-type: none"> • Adhesive 	160x200
043-160-300S	1 PC	Surgical Sheet	160x300
30251-0000	1 PC	Lamino Spinal Drape <ul style="list-style-type: none"> • Absorbent Laminated Reinforcement • Tube Holder • Pockets • Hygiene Sheet • Incise • 25x15 Cm Fenestration 	260x300
CP 141066-000	1 PC	Carry Bag	



Universal Extremity Pack : Product Code - #66724-0000

UNIVERSAL EXTREMITY DRAPE

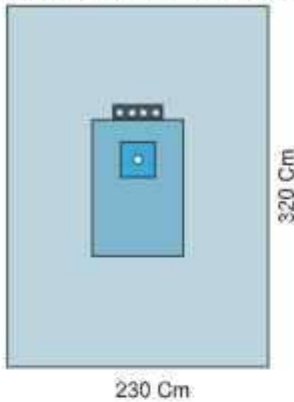

LEG-U-DRAPE

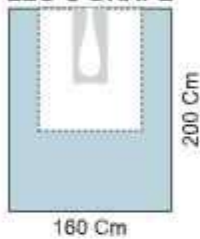

Item Code	Qty.	Contents	Size(cm)
318-160-200S	1 PC	Back Table Cover Reinforced	160x200
CR 143027-038	3 PCS	Surgical Gown Wrap Around	L
CR 143029-000	3 PCS	Hand Towel	30x30
CR 143027-009	1 PC	Cardiac Gown	L
CR 143029-000	1 PC	Hand Towel	30x30
CR 143041-012	10 PCS	Mopping Pad	30x30
318-160-200S	1 PC	Trolley Sheet	160x200
30271-0000	1 PC	LEG U* Drape	160x200
		<ul style="list-style-type: none"> • Adhesive • Hygiene Sheet • 17x73 Cm Split 	
44004-0000	1 PC	Universal Extremity Drape	230x320
		<ul style="list-style-type: none"> • Absorbent Laminated Reinforcement • Tube Holder 	
CR 143079-000	1 PC	Stockinette	L 10x200
CP 141066-000	1 PC	Carry Bag	

TKR Pack I : Product Code - #66706-0001

LEG-U-DRAPE

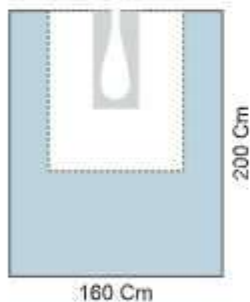

SURGICAL SHEET

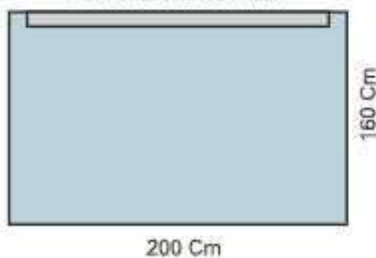

Item Code	Qty.	Contents	Size(cm)
085-160-230S	1 PC	Back Table Cover Reinforced	160x230
CR 143027-038	6 PCS	Surgical Gown Wrap Around	L
CR 143029-000	6 PCS	Hand Towel	30x30
085-160-230S	1 PC	Trolley Sheet Laminated Reinforced	160x230
043-160-260A	4 PCS	Screen Sheet	160x260
		<ul style="list-style-type: none"> • Adhesive 	
043-160-200A	3 PCS	Surgical Sheet	160x200
		<ul style="list-style-type: none"> • Adhesive 	
043-130-100A	5 PCS	Surgical Sheet	130x100
		<ul style="list-style-type: none"> • Adhesive 	
30271-0000	1 PC	LEG U* Drape	160x200
		<ul style="list-style-type: none"> • Adhesive • Hygiene Sheet • 17x73 Cm Split 	120x100
CP 141066-000	1 PC	Carry Bag	



TKR Pack II : Product Code - #66706-0002

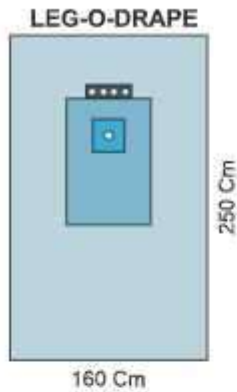

Item Code	Qty.	Contents	Size(cm)
085-160-230S	1 PC	Back Table Cover Reinforced	160x230
043-080-100S	2 PCS	Surgical Sheet	100x80
043-100-250S	4 PCS	Surgical Sheet	100x250
043-160-150S	3 PCS	Surgical Sheet	160x150
44002-0000	1 PC	LEG O" Drape	150x160
		<ul style="list-style-type: none"> Absorbent Laminated Reinforcement Tube Holder 	
085-160-230S	1 PC	Trolley Sheet Laminated Reinforcement	160x230
CP 141066-000	1 PC	Carry Bag	

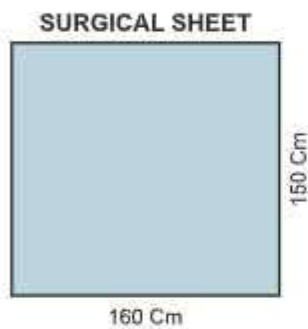

Bilateral Knee Pack : Product Code - #66701-0000

BILATERAL KNEE-O-DRAPE

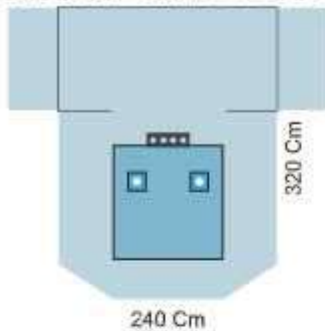

LEG-U-DRAPE

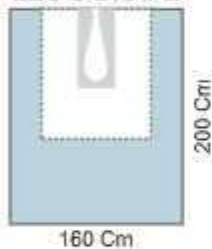

Item Code	Qty.	Contents	Size(cm)
318-160-200S	1 PC	Back Table Cover Reinforced	160x200
CR 143027-009	1 PC	Cardiac Gown	L
CR 143029-030	1 PC	Hand Towel	30x30
CR 143027-038	3 PCS	Surgical Gown Wrap Around	L
CR 143027-000	3 PCS	Hand Towel	30x30
043-160-200A	2 PCS	Surgical Sheet with Adhesive	160x200
		• Adhesive	
043-080-100A	2 PCS	Surgical Sheet with Adhesive	100x80
		• Adhesive	
CR 143041-012	15 PCS	Mopping Pad	30x30
3036-0000	1 PC	Bilateral Knee O ^o Drape	320x240
		• Absorbent Laminated Reinforcement	
		• Tube Holder	
		• Arm Board Covers	
30271-0000	2 PCS	LEG U ^o Drape	160x200
		• Adhesive	
		• Hygiene Sheet	120x100
		• 17x73 Cm Split	
318-160-200S	1 PC	Trolley Sheet	160x200
CP 141066-000	1 PC	Carry Bag	

Hand Pack : Product Code - #66511-0000

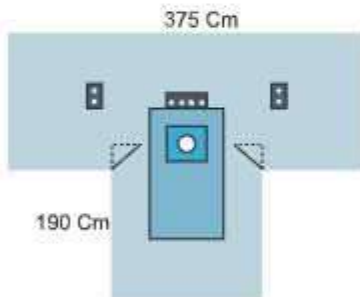

IMPERVIOUS SPLIT SHEET

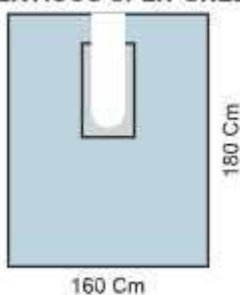

Item Code	Qty.	Contents	Size(cm)
085-160-125S	1 PC	Back Table Cover Reinforced	160x125
CR 143027-027	1 PC	Surgical Gown Overlap	XL
CR 143029-000	2 PCS	Hand Towels	30x30
CR 143039-000	1 PC	Mayo Stand Cover Reinforced	80x80
043-060-040A	2 PCS	Utility Drape	60x40
		• Adhesive	
CC 142002-001	1 PC	Diathermy Bag	30x35
		• Adhesive	
043-160-200S	1 PC	Surgical Sheet	160x200
41015-0000	1 PC	Impervious Split Sheet	160x80
		• 10x52 Cm Split	
		• Adhesive	
CR 143079-000	1 PC	Stockinette	L 10x200
CR 143041-012	6 PCS	Mopping Pad	30x30
44012-0000	1 PC	Hand Drape with Arm Board Covers	375x190
		• Absorbent Laminated Reinforcement	
		• Tube Holder	
		• Arm Board Covers	
CP 141066-000	1 PC	Carry Bag	



Shoulder Arthroscopy Pack I : Product Code - #66121-0001

SHOULDER ARTHROSCOPY DRAPE

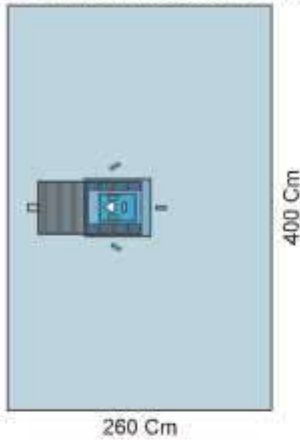

MAYO STAND COVER

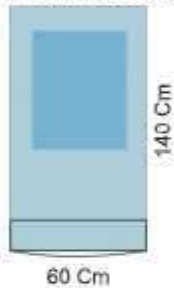

Item Code	Qty.	Contents	Size(cm)
085-160-100S	1 PC	Back Table Cover Reinforced	160x100
CR 143027-009	3 PCS	Cardiac Gown	L
CR 143029-000	3 PCS	Hand Towels	30x30
085-350-075S	1 PC	Trolley Sheet with Absorbent Laminated Reinforcement	350x75
CR 143039-004	1 PC	• Absorbent Laminated Reinforcement	100x75
3021-0000	1 PC	Mayo Stand Cover Reinforced	140x60
		Shoulder Arthroscopy Drape	400x260
		• Absorbent Laminated Reinforcement	
		• Fluid Collection Pouch with Pocket	
CP 141066-000	1 PC	Carry Bag	

Shoulder Arthroscopy Lateral Pack II : Product Code - #66121-0002

SHOULDER ARTHROSCOPY LATERAL

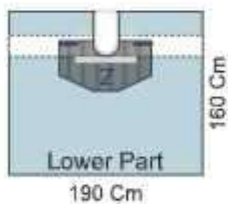
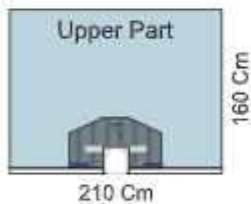

CAMERA COVER



Item Code	Qty.	Contents	Size(cm)
318-160-200S	1 PC	Back Table Cover Reinforced	160x200
CR 143027-038	5 PCS	Surgical Gown Wrap Around	L
CR 143029-000	5 PCS	Hand Towel	30x30
30151-0000	1 PC	Shoulder Arthroscopy Drape Lateral	210x160
		• 28x15 Split	
		• 20x15 Split	
		• Fluid Collection Pouch	
		• Adhesive	
		• Absorbent Laminated Reinforcement	
CR 143005-000	2 PCS	Apron	XL
CR 143010-002	3 PCS	Camera Cover	240x20
		• Card Board Support	
		• Adhesive with Release	
CP 141066-000	1 PC	Carry Bag	

